

# GUIDA ALL' ACQUISTO

*Divisione bagno*

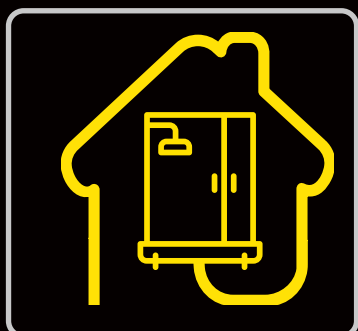

*Box & piatti doccia  
Sistemi di scarico  
Complementi doccia*

*Prodotti, soluzioni  
& accessori*

# FERRARI

[www.ferrariwelcome.it](http://www.ferrariwelcome.it)





*Inquadra i QR code presenti in alcune pagine di questo catalogo per avere maggiori informazioni sul prodotto, schede tecniche, video esplicativi e tanto altro!*



*Inquadra questo QR code per essere sempre aggiornato sulle modifiche tecniche, errata corrige, novità prodotti, ecc.*



*Ferrari s.r.l. dichiara che i prodotti qui inseriti sono realizzati a regola d'arte e, dove richiesto, sono certificati per l'idoneità di utilizzo secondo le norme vigenti. I prodotti nel presente catalogo sono da intendersi ad esclusivo uso professionale e destinati a soggetti in possesso della professionalità richiesta per il tipo di prodotto, con espressa esclusione dei consumatori. La buona rispondenza dei materiali agli usi espressamente indicati è condizionata alla corretta installazione oltre che al corretto dimensionamento ed utilizzo degli accessori previsto dalle norme. La nostra responsabilità è limitata alla qualità dei materiali; le illustrazioni, le foto, le misure e quant'altro indicato non sono impegnative e possono variare senza alcun obbligo di preavviso.*



Sono la **passione** e la **curiosità** a guidare l'innovazione.  
Se non si ha **passione**, non si ha **energia**.

Questi principi sono gli elementi che caratterizzano, da oltre 60 anni, tutto il nostro team composto da molti collaboratori di "lungo corso" e da giovani risorse che creano il giusto mix ricco di esperienza e professionalità proiettato verso il futuro portandoci a sviluppare servizi, proposte e soluzioni al passo con i tempi.

La **passione** è l'elemento trainante, una continua evoluzione e ricerca dedita a supportare i continui cambiamenti del nostro mercato, un confronto costruttivo e continuo con tutti i nostri clienti, partner e collaboratori.

La **curiosità** ci porta ad esplorare nuovi settori, consentendoci di accrescere le nostre competenze permettendoci di offrire prodotti innovativi che soddisfano e anticipano le esigenze del mercato.

La nuova proposta di cataloghi specifici che presentiamo segna un passo in avanti nella crescita della Ferrari; una leva importante che, attraverso una più profonda focalizzazione delle gamme di prodotti, vuole fidelizzare e supportare gli attuali clienti e collaboratori sviluppando nuove partnership.

Buona consultazione!



# Linea LOFTY

quando sono i dettagli a fare la differenza

La funzionalità è il cuore di ogni ambiente domestico ma soprattutto del tuo bagno. Se unita allo stile, il risultato è un arredo pensato per ogni necessità che non rinuncia a qualità ed estetica. Da qui nasce la linea di box doccia LOFTY: essenziale nelle sue finiture, pratica e curata in ogni minimo dettaglio.

**VANTAGGI**

**FACILE DA MONTARE**

**CHIUSURA MAGNETICA  
SILENZIATA**

**AMPIA GAMMA  
DI MISURE**

**REVERSIBILE**

**ESTENSIBILE**

**SGANCIO RAPIDO**

**ANTIBATTERICO**

**ANTIMUFFA**

Profilo coprifissaggi



Particolare copertura



Particolare maniglia



Particolare porta soffietto



**Caratteristiche**

Altezza	200 cm
Cristallo	Trasparente spessore 6mm (8 mm Walk-in) Norma EN12150 -1
Profili	Alluminio cromato lucido con coprifissaggio
Maniglie	Cromate



**TIPOLOGIE DISPONIBILI:**



**Lato per angolo  
con apertura  
scorrevole laterale**



**Porta a due ante  
con apertura  
scorrevole laterale**



**Porta a tre ante  
con apertura  
scorrevole laterale**



**Porta battente  
pivot**



**Porta a soffietto con  
apertura interna  
(esterna antipanico)**



**Parete  
laterale**



**Parete  
doccia Walk-in**

**POSSIBILI COMBINAZIONI:**
**ANGOLO**

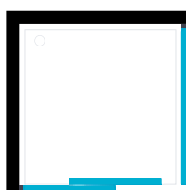

2 x LATO  
SCORREVOLE  
A DUE ANTE



1 x LATO FISSO  
+  
1 x PORTA  
SCORREVOLE  
A DUE ANTE

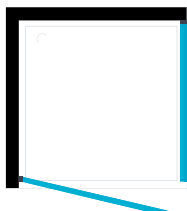

1 x LATO FISSO  
+  
1 x PORTA  
SCORREVOLE  
A TRE ANTE



1 x LATO FISSO  
+  
1 x PORTA  
A BATTENTE



1 x LATO FISSO  
+  
1 x PORTA  
A SOFFIETTO

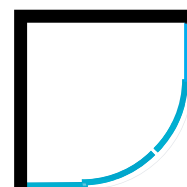

1 x ANGOLARE  
SEMICIRCOLARE

**CENTRO PARETE**

2 x LATO FISSO  
+  
1 x PORTA  
SCORREVOLE  
A DUE ANTE



2 x LATO FISSO  
+  
1 x PORTA  
SCORREVOLE  
A TRE ANTE



2 x LATO FISSO  
+  
1 x PORTA  
A BATTENTE



2 x LATO FISSO  
+  
1 x PORTA  
A SOFFIETTO



1 x LATO FISSO  
+  
2 x LATO  
SCORREVOLE  
A DUE ANTE

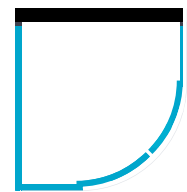

1 x LATO FISSO  
+  
1 x ANGOLARE  
SEMICIRCOLARE

**NICCHIA**

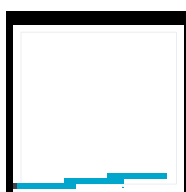

1 x PORTA  
SCORREVOLE  
A DUE ANTE

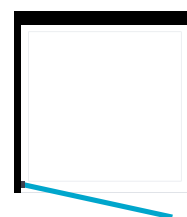

1 x PORTA  
SCORREVOLE  
A TRE ANTE

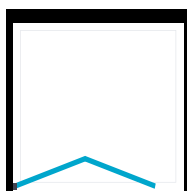

1 x PORTA  
A BATTENTE

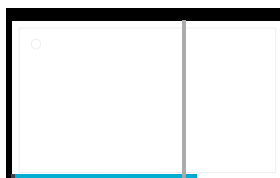

1 x PORTA  
A SOFFIETTO

**WALK-IN**

1 x WALK-IN  
CON BRACCIO

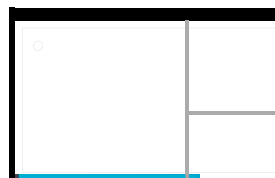

2 x WALK-IN  
CON 1 BRACCIO A T

**LATO PER ANGOLO  
APERTURA SCORREVOLE LATERALE**



CODICE	EURO/PZ	VERSIONE		PZ
		L cm	Estensibilità cm	
601630		65	63 ÷ 65	1
601631		70	68 ÷ 70	1
601632		75	73 ÷ 75	1
601633		80	78 ÷ 80	1
601634		90	88 ÷ 90	1
601635		100	98 ÷ 100	1
601636		110	108 ÷ 110	1
601637		120	118 ÷ 120	1
601638		130	128 ÷ 130	1
601639		140	138 ÷ 140	1



Esempio con 2 lati  
angolari

# Linea LOFTY

PORTA A DUE ANTE  
CON APERTURA SCORREVOLE LATERALE



BOX DOCCIA

Linea LOFTY

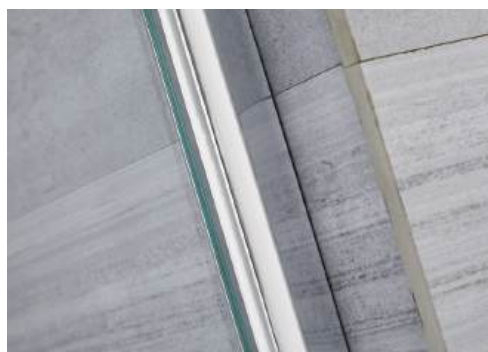

Esempio con parete laterale

CODICE	EURO/PZ	VERSIONE			PZ
		L cm	Estensibilità cm	Ingresso cm	
601640		100	96 ÷ 100	42	1
601641		110	106 ÷ 110	46	1
601642		120	116 ÷ 120	51	1
601664		130	126 ÷ 130	56	1
601643		140	136 ÷ 140	60	1
601663		150	146 ÷ 150	65	1
601644		160	156 ÷ 160	70	1
601645		170	166 ÷ 170	75	1

# Linea LOFTY

**PORTA SCORREVOLE A TRE ANTE  
CON APERTURA SCORREVOLE LATERALE**

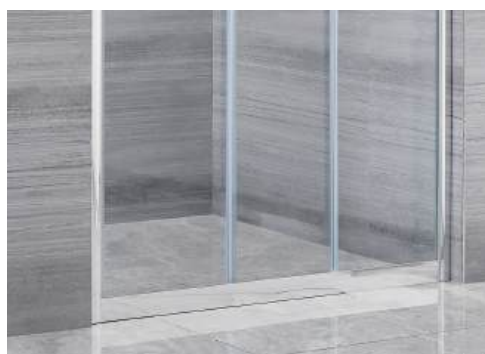

Esempio con parete laterale

CODICE	EURO/PZ	VERSIONE			PZ
		L cm	Estensibilità cm	Ingresso cm	
601646		100	96 ÷ 100	52	1
601647		110	106 ÷ 110	58	1
601648		120	116 ÷ 120	65	1

# Linea LOFTY

PORTA BATTENTE PIVOT



BOX DOCCIA

Linea LOFTY

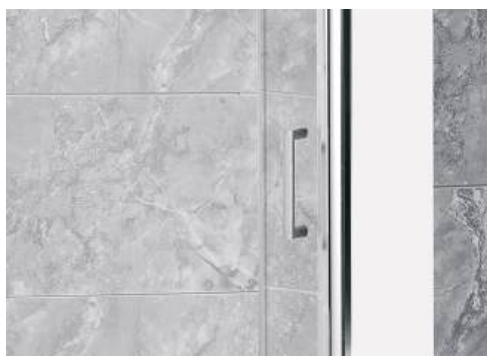

CODICE	EURO/PZ	VERSIONE			PZ
		L cm	Estensibilità cm	Ingresso cm	
601649		70	66 ÷ 70	58	1
601650		75	71 ÷ 75	63	1
601651		80	76 ÷ 80	68	1
601652		90	86 ÷ 90	78	1

# Linea LOFTY

PORTA A SOFFIETTO  
CON APERTURA INTERNO/ESTERNO (ANTIPANICO)

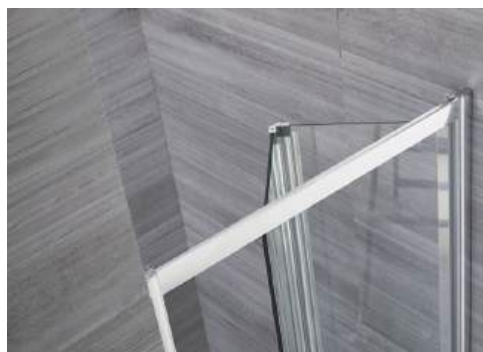

CODICE	EURO/PZ	VERSIONE			PZ
		L cm	Estensibilità cm	Ingresso cm	
601653		70	66 ÷ 70	42	1
601654		75	71 ÷ 75	46	1
601655		80	76 ÷ 80	49,5	1
601656		90	86 ÷ 90	57	1
601665		100	96 ÷ 100	65	1



Esempio apertura esterna  
(antipanico)

# Linea LOFTY

ANGOLARE SEMICIRCOLARE  
CON APERTURA CENTRALE (R. 55 CM)



BOX DOCCIA

Linea LOFTY



Apertura centrale

CODICE	EURO/PZ	VERSIONE			PZ
		L cm	Estensibilità cm	Ingresso cm	
601657		80x80	78 ÷ 80 x 78 ÷ 80	46	1
601658		90x90	88 ÷ 90 x 88 ÷ 90	52	1

# Linea LOFTY

## PARETE LATERALE



CODICE	EURO/PZ	VERSIONE		PZ
		L cm	Estensibilità cm	
601659		70	68 ÷ 70	1
601660		75	73 ÷ 75	1
601661		80	78 ÷ 80	1
601662		90	88 ÷ 90	1



# Linea LOFTY

## PARETE DOCCIA WALK IN

Spessore cristallo: **8 mm**, incluso braccetto stabilizzatore telescopico in ottone cromato da 80 a 120 cm.



Esempio WALK-IN 1 lato con 1 braccio

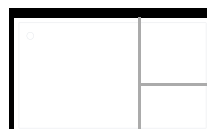

Esempio WALK-IN 2 lati con 2 bracci e raccordo

CODICE	EURO/PZ	VERSIONE		PZ
		L cm	Estensibilità cm	
601097		70	67 ÷ 69	1
601099		80	77 ÷ 79	1
601101		90	87 ÷ 89	1
601103		100	97 ÷ 99	1
601105		110	107 ÷ 109	1
601107		120	117 ÷ 119	1
601109		140	137 ÷ 139	1
601111		150	147 ÷ 149	1
601113		160	157 ÷ 159	1

### RACCORDO PER DUE PARETI DOCCIA WALK - IN

CODICE	EURO/PZ	PZ
601710		1



**COPPIA DI CUSCINETTI SCORREVOLI**

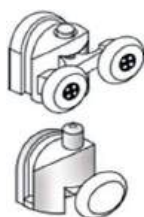

Coppia di cuscinetti scorrevoli uno superiore e uno inferiore.  
**Per modelli:**  
 angolo - semicircolare  
 porta scorrevole

CODICE	EURO/CONF.	PZ.
601695		1

**PROFILO DI COMPENAZIONE**

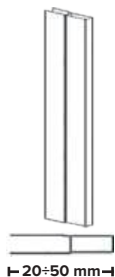

**Per modelli:**  
 angolo - semicircolare - porta scorrevole - porta pivot scorrevole a tre ante  
 porta a soffietto - parete laterale

CODICE	EURO/PZ	PZ.
601690		1

**PROFILO MURO**

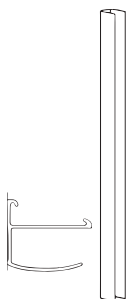

**Per modelli:**  
 angolo - semicircolare - porta scorrevole - porta pivot scorrevole a tre ante  
 porta a soffietto - parete laterale

CODICE	EURO/PZ	PZ.
601708		1

**PROFILO COPRIFISSAGGI**



**Per modelli:**  
 angolo - semicircolare - porta scorrevole - porta pivot scorrevole a tre ante  
 porta a soffietto - parete laterale

CODICE	EURO/PZ	PZ.
601691		1

**KIT DI GIUNZIONE ANGOLARE**

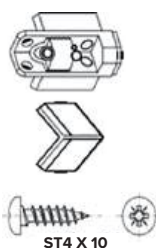

**Per modelli:** angolo

CODICE	EURO/PZ	PZ.
601707		1

**KIT DI FISSAGGIO PROFILO A MURO**

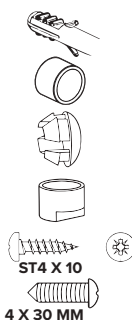

**Per modelli:**  
 angolo - semicircolare  
 porta scorrevole - porta pivot scorrevole a tre ante  
 porta a soffietto - parete laterale

CODICE	EURO/PZ	PZ.
601692		1

**MANIGLIA COMPLETA PER PORTA**  
 parte interna ed esterna



**Per modelli:**  
 angolo - semicircolare - porta scorrevole - porta pivot scorrevole a tre ante  
 porta a soffietto - parete laterale

CODICE	EURO/PZ	PZ.
601711		1

**KIT FERMAPORTA**

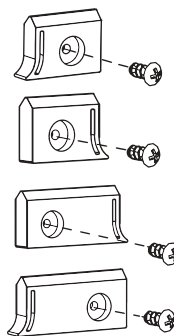

**Per modelli:**  
 angolo - semicircolare  
 porta scorrevole

CODICE	EURO/PZ	PZ.
601705		1

**COPERCHI PER PROFILI VERTICALI PER MONTANTE**

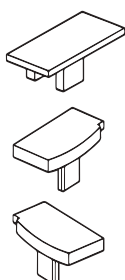

**Per modelli:**  
 angolo - semicircolare - porta scorrevole - porta pivot scorrevole a tre ante

CODICE	EURO/PZ	PZ.
601694		1

**COPERCHI PER PROFILI VERTICALI PER MONTANTE**

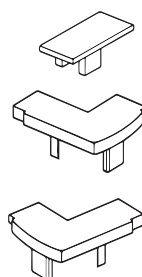

**Per modello:**  
 parete fissa

CODICE	EURO/PZ	PZ.
601693		1

**GUARNIZIONE A BAFFO ESTERNO 1 X BOX  
(L. 1820 MM)**

**Per modelli:**  
angolo - semicircolare  
porta scorrevole

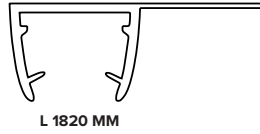

CODICE	EURO/PZ	PZ.
601703		1

**GUARNIZIONE A BAFFO INTERNO 1 X BOX  
(L. 1880 MM)**

**Per modelli:**  
angolo - semicircolare  
porta scorrevole

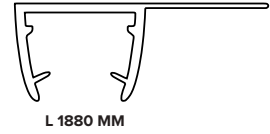

CODICE	EURO/PZ	PZ.
601702		1

**GUARNIZIONE A PALLONCINO 1 X BOX**

**Per modelli:**  
angolo - semicircolare  
porta scorrevole

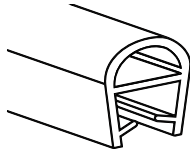

CODICE	EURO/PZ	PZ.
601699		1

**GUARNIZIONE MAGNETICA 1 X BOX  
2 PEZZI**

**Per modello:**  
semicircolare

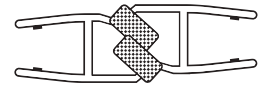

CODICE	EURO/PZ	PZ.
601698		1

**GUARNIZIONE MAGNETICA AD ANGOLO  
1 X BOX**

**Per modello:** angolo

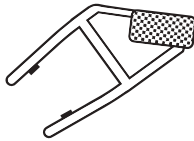

CODICE	EURO/PZ	PZ.
601697		1

**GUARNIZIONE VERTICALE PER PORTA PIVOT  
1 X BOX**

**Per modello:**  
porta pivot



CODICE	EURO/PZ	PZ.
601701		1

**GUARNIZIONE MAGNETICA PER PORTA PIVOT  
1 X BOX**

**Per modello:**  
porta pivot

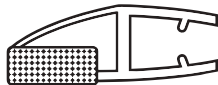

CODICE	EURO/PZ	PZ.
601700		1

**GUARNIZIONE INFERIORE PER PORTA PIVOT  
1 X BOX**

**Per modello:**  
porta pivot

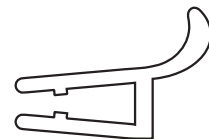

CODICE	EURO/PZ	PZ.
601696		1

**GUARNIZIONE MAGNETICA PER SCORREVOLE  
1 X BOX**

**Per modello:**  
porta scorrevole

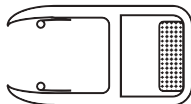

CODICE	EURO/PZ	PZ.
601704		1

**KIT DI FISSAGGIO PER PROFILO  
DI COMPENSAZIONE**

**Per modelli:**  
angolo - semicircolare  
porta scorrevole - porta pivot  
scorrevole a tre ante  
porta a soffietto - parete laterale

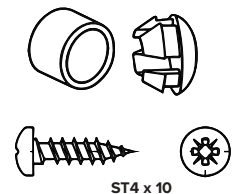

CODICE	EURO/PZ	PZ.
601706		1

**ANGOLO DOCCIA  
CON APERTURA SCORREVOLE LATERALE**



**Caratteristiche**

Altezza	190 cm
Pannello	spessore 1,8 mm
Profili	PVC bianco pastello
Chiusure	magnetiche



CODICE	EURO/PZ	VERSIONE		PZ
		Dimensioni cm	Ingresso cm	
601800		70÷65 x 70÷65	38	1
601801		70÷65 x 90÷85	46	1
601802		70÷65 x 100÷95	50	1
601803		70÷65 x 120÷115	58	1
601804		75÷70 x 75÷70	42	1
601805		75÷70 x 90÷85	47	1
601806		80÷75 x 80÷75	45	1
601807		80÷75 x 100÷95	53	1
601808		80÷75 x 120÷115	61	1
601809		90÷85 x 90÷85	52	1
601810		100÷95 x 100÷95	59	1

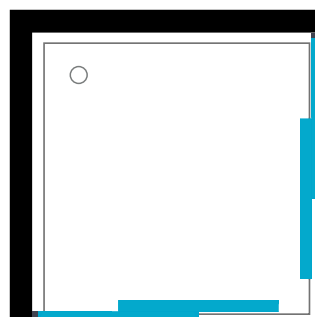

# Linea ACRIL

ESTENSIBILE - REVERSIBILE - RIDUCIBILE

PORTA SCORREVOLE A DUE ANTE PER NICCHIA  
CON APERTURA SCORREVOLE LATERALE

## Caratteristiche

Altezza	190 cm
Pannello	spessore 1,8 mm
Profili	PVC bianco pastello
Chiusure	magnetiche

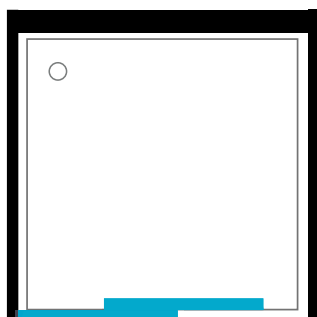

CODICE	EURO/PZ	VERSIONE		PZ
		Dimensioni cm	Ingresso cm	
601815		100÷90	42	1
601816		110÷100	47	1
601817		120÷110	52	1
601818		130÷120	57	1
601819		140÷130	62	1
601820		150÷140	66	1

**Linea ACRIL**  
ESTENSIBILE - REVERSIBILE - RIDUCIBILE

**PARETE LATERALE**



**Caratteristiche**

Altezza	190 cm
Pannello	spessore 1,8 mm
Profili	PVC bianco pastello
Chiusure	magnetiche

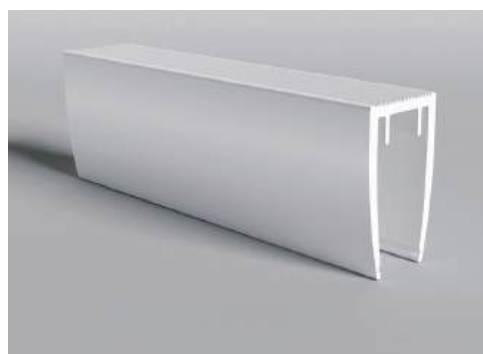

CODICE	EURO/PZ	VERSIONE Dimensioni cm	PZ
601825		67÷70	1
601826		72÷75	1
601827		77÷80	1
601828		87÷90	1

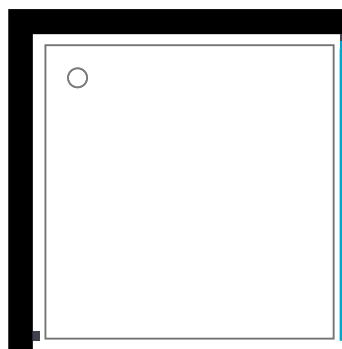

# Linea ACRIL

ESTENSIBILE - REVERSIBILE - RIDUCIBILE

ANGOLARE DOCCIA SEMICIRCOLARE  
CON APERTURA CENTRALE (R. 55 CM)

## Caratteristiche

Altezza	190 cm
Pannello	spessore 2,2 mm
Profili	PVC bianco pastello
Chiusure	magnetiche

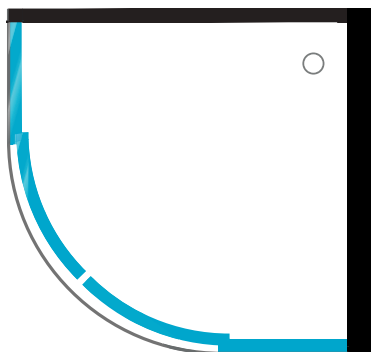

CODICE	EURO/PZ	VERSIONE		PZ
		Dimensioni cm	Ingresso cm	
601835		80÷75 x 80÷75	48	1
601836		90÷85 x 90÷85	55	1
601837		100÷95 x 100÷95	62	1

# PIATTO DOCCIA ZERO Mineral Plane

Design, stile e funzionalità si incontrano per dar vita a questa collezione unica e moderna

I piatti doccia **extra piani ZERO** sono fabbricati con una base strutturale, realizzata con una carica minerale ottenuta dalla miscelazione di Dolomia e Silice tixotropica e resina poliestere isoftalica. Tale base strutturale viene ricoperta con un particolare e spesso strato di gel coat di resina poliestere ISO NPG lavorata con una particolare tecnologia implementata direttamente dal produttore. La particolare composizione della carica minerale della struttura, **priva di carbonato di calcio**, garantisce uniformità, stabilità dimensionale, forte resistenza alle sollecitazioni meccaniche, termiche e alla corrosione. Il rivestimento del particolare geal coat ISO NPG inoltre garantisce una grande resistenza all'usura e agli urti accidentali e una Classe 3 antiscivolo.

Disponibili in 4 colori standard e 47 misure.  
Texture : ardesia

**VANTAGGI**

<b>ANTISCIVOLO CLASSE 3</b>	<b>RESISTE AI RAGGI UV</b>	<b>BORDI RIFINITI TAGLIABILI</b>	<b>35% DI PESO RIDOTTO</b>	<b>FACILE DA PULIRE ESENTE DA IDROLISI</b>
<b>ANTIBATTERICO</b>	<b>RIPARABILE</b>	<b>ELEVATA DUREZZA</b>	<b>TAGLIABILE</b>	

**Caratteristiche**

Materiale	resina e carica minerale e miscela oftalmica
Copertura	gel coat spessore 2,5÷2,7 mm
Antiscivolo	UNE ENV 12633 - Classe 3
Idoneità pulizia e durata	UNE EN 14527 - Class 1
Durezza Barcol	4,5
Soglia tolleranza curvatura	0,3%
Scarico sifone	orizzontale c/fissaggio a ghiera a tre viti
Capacità di scarico sifone	58 litri/min
Griglia	inossidabile - in tinta con il piatto

**DIMENSIONI PIATTO**

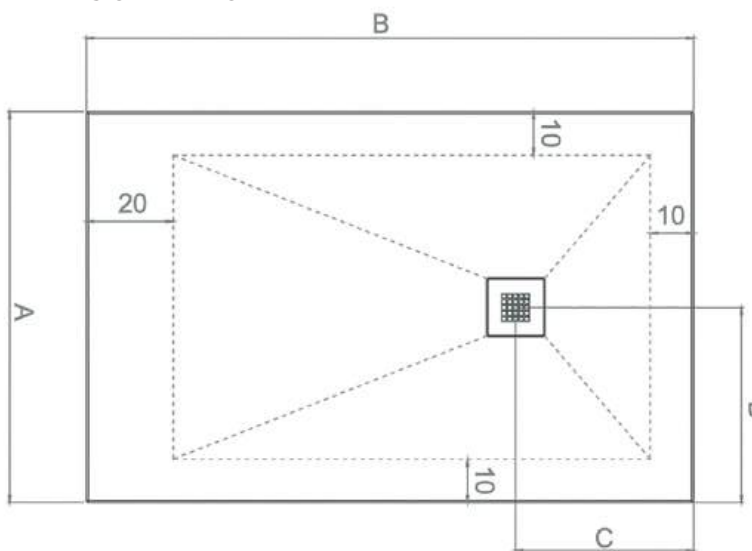

A	B	C	D
70	90 / 100 / 120 / 130 / 140 / 150 / 160	41	35
	170 / 180 / 200	61	
75	100 / 120 / 130 / 140 / 150 / 160	41	37,5
	170 / 180	61	
80	80	40	40
	90 / 100 / 120 / 130 / 140 / 150 / 160	41	
	170 / 180 / 200	61	
	90	45	
90	100	50	45
	120 / 140	45	
	160	41	
	180/200	61	
100	100	50	50
	120 / 140	45	
	160/ 180/200	61	
	215	77	
110	200	61	55

(Quote in cm)

2'5 - 2,7 cm

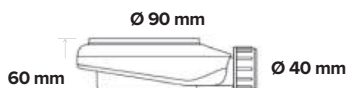

DIMENSIONI SIFONE



VALVOLA INCLUSA  
58 litri/min

**GRIGLIA IN TINTA CON IL PIATTO  
INCLUSA**

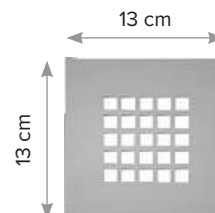

FINITURE



BIANCO

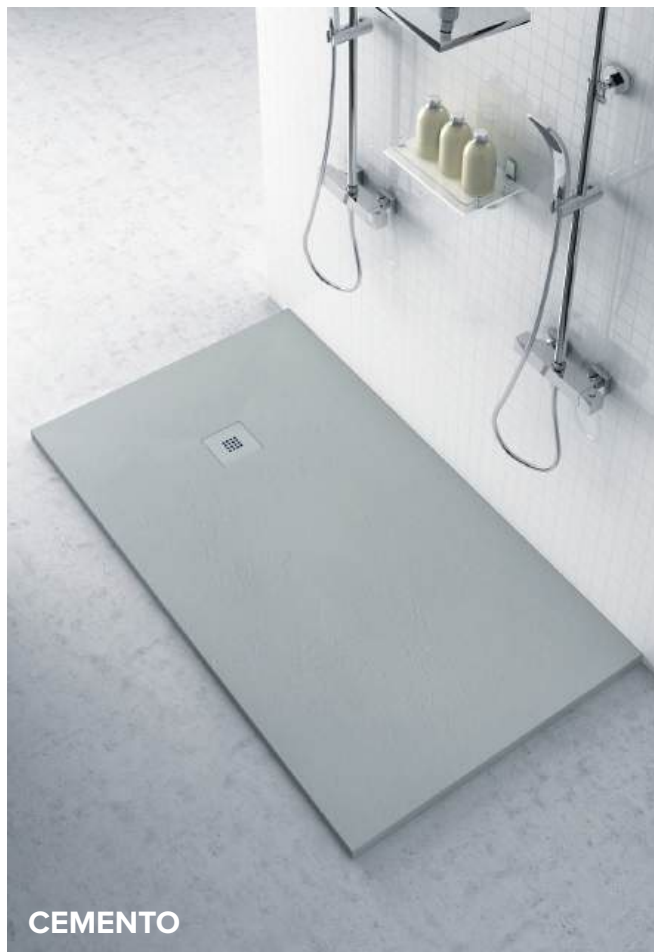

CEMENTO



ANTRACITE



CORDA



## Piatto doccia ZERO - 700 mm

CODICE	EURO/PZ	VERSIONE		PZ
		Dimensioni mm	Finitura	
602000		700 x 900	bianco	1
602001			cemento	1
602002			antracite	1
602003			corda	1

CODICE	EURO/PZ	VERSIONE		PZ
		Dimensioni mm	Finitura	
602005		700 x 1000	bianco	1
602006			cemento	1
602007			antracite	1
602008			corda	1

CODICE	EURO/PZ	VERSIONE		PZ
		Dimensioni mm	Finitura	
602015		700 x 1200	bianco	1
602016			cemento	1
602017			antracite	1
602018			corda	1

CODICE	EURO/PZ	VERSIONE		PZ
		Dimensioni mm	Finitura	
602020		700 x 1300	bianco	1
602021			cemento	1
602022			antracite	1
602023			corda	1

CODICE	EURO/PZ	VERSIONE		PZ
		Dimensioni mm	Finitura	
602025		700 x 1400	bianco	1
602026			cemento	1
602027			antracite	1
602028			corda	1

CODICE	EURO/PZ	VERSIONE		PZ
		Dimensioni mm	Finitura	
602030		700 x 1500	bianco	1
602031			cemento	1
602032			antracite	1
602033			corda	1

CODICE	EURO/PZ	VERSIONE		PZ
		Dimensioni mm	Finitura	
602035		700 x 1600	bianco	1
602036			cemento	1
602037			antracite	1
602038			corda	1

CODICE	EURO/PZ	VERSIONE		PZ
		Dimensioni mm	Finitura	
602040		700 x 1700	bianco	1
602041			cemento	1
602042			antracite	1
602043			corda	1

CODICE	EURO/PZ	VERSIONE		PZ
		Dimensioni mm	Finitura	
602045		700 x 1800	bianco	1
602046			cemento	1
602047			antracite	1
602048			corda	1

CODICE	EURO/PZ	VERSIONE		PZ
		Dimensioni mm	Finitura	
602050		700 x 2000	bianco	1
602051			cemento	1
602052			antracite	1
602053			corda	1

## Piatto doccia ZERO - 750 mm

CODICE	EURO/PZ	VERSIONE		PZ
		Dimensioni mm	Finitura	
602060		750 x 1000	bianco	1
602061			cemento	1
602062			antracite	1
602063			corda	1

CODICE	EURO/PZ	VERSIONE		PZ
		Dimensioni mm	Finitura	
602070		750 x 1200	bianco	1
602071			cemento	1
602072			antracite	1
602073			corda	1

CODICE	EURO/PZ	VERSIONE		PZ
		Dimensioni mm	Finitura	
602075		750 x 1300	bianco	1
602076			cemento	1
602077			antracite	1
602078			corda	1

CODICE	EURO/PZ	VERSIONE		PZ
		Dimensioni mm	Finitura	
602080		750 x 1400	bianco	1
602081			cemento	1
602082			antracite	1
602083			corda	1

CODICE	EURO/PZ	VERSIONE		PZ
		Dimensioni mm	Finitura	
602085		750 x 1500	bianco	1
602086			cemento	1
602087			antracite	1
602088			corda	1

CODICE	EURO/PZ	VERSIONE		PZ
		Dimensioni mm	Finitura	
602090		750 x 1600	bianco	1
602091			cemento	1
602092			antracite	1
602093			corda	1



CODICE	EURO/PZ	VERSIONE		PZ
		Dimensioni mm	Finitura	
602095		750 x 1700	bianco	1
602096			cemento	1
602097			antracite	1
602098			corda	1

CODICE	EURO/PZ	VERSIONE		PZ
		Dimensioni mm	Finitura	
602100		750 x 1800	bianco	1
602101			cemento	1
602102			antracite	1
602103			corda	1

## Piatto doccia ZERO - 800 mm

CODICE	EURO/PZ	VERSIONE		PZ
		Dimensioni mm	Finitura	
602110		800 x 800	bianco	1
602111			cemento	1
602112			antracite	1
602113			corda	1

CODICE	EURO/PZ	VERSIONE		PZ
		Dimensioni mm	Finitura	
602115		800 x 900	bianco	1
602116			cemento	1
602117			antracite	1
602118			corda	1

CODICE	EURO/PZ	VERSIONE		PZ
		Dimensioni mm	Finitura	
602120		800 x 1000	bianco	1
602121			cemento	1
602122			antracite	1
602123			corda	1

CODICE	EURO/PZ	VERSIONE		PZ
		Dimensioni mm	Finitura	
602130		800 x 1200	bianco	1
602131			cemento	1
602132			antracite	1
602133			corda	1

CODICE	EURO/PZ	VERSIONE		PZ
		Dimensioni mm	Finitura	
602135		800 x 1300	bianco	1
602136			cemento	1
602137			antracite	1
602138			corda	1

CODICE	EURO/PZ	VERSIONE		PZ
		Dimensioni mm	Finitura	
602140		800 x 1400	bianco	1
602141			cemento	1
602142			antracite	1
602143			corda	1

CODICE	EURO/PZ	VERSIONE		PZ
		Dimensioni mm	Finitura	
602145		800 x 1500	bianco	1
602146			cemento	1
602147			antracite	1
602148			corda	1

CODICE	EURO/PZ	VERSIONE		PZ
		Dimensioni mm	Finitura	
602150		800 x 1600	bianco	1
602151			cemento	1
602152			antracite	1
602153			corda	1

CODICE	EURO/PZ	VERSIONE		PZ
		Dimensioni mm	Finitura	
602155		800 x 1700	bianco	1
602156			cemento	1
602157			antracite	1
602158			corda	1

CODICE	EURO/PZ	VERSIONE		PZ
		Dimensioni mm	Finitura	
602160		800 x 1800	bianco	1
602161			cemento	1
602162			antracite	1
602163			corda	1

CODICE	EURO/PZ	VERSIONE		PZ
		Dimensioni mm	Finitura	
602165		800 x 2000	bianco	1
602166			cemento	1
602167			antracite	1
602168			corda	1

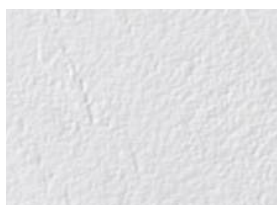
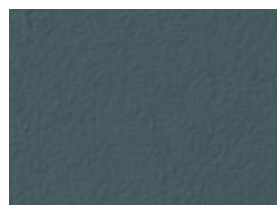
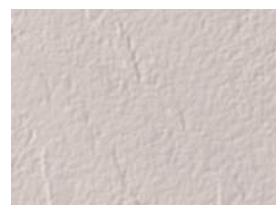
**BIANCO****CEMENTO****ANTRACITE****CORDA**

## Piatto doccia ZERO - 900 mm

CODICE	EURO/PZ	VERSIONE		PZ
		Dimensioni mm	Finitura	
602170		900 x 900	bianco	1
602171			cemento	1
602172			antracite	1
602173			corda	1

CODICE	EURO/PZ	VERSIONE		PZ
		Dimensioni mm	Finitura	
602175		900 x 1000	bianco	1
602176			cemento	1
602177			antracite	1
602178			corda	1

CODICE	EURO/PZ	VERSIONE		PZ
		Dimensioni mm	Finitura	
602185		900 x 1200	bianco	1
602186			cemento	1
602187			antracite	1
602188			corda	1

CODICE	EURO/PZ	VERSIONE		PZ
		Dimensioni mm	Finitura	
602195		900 x 1400	bianco	1
602196			cemento	1
602197			antracite	1
602198			corda	1

CODICE	EURO/PZ	VERSIONE		PZ
		Dimensioni mm	Finitura	
602205		900 x 1600	bianco	1
602206			cemento	1
602207			antracite	1
602208			corda	1

CODICE	EURO/PZ	VERSIONE		PZ
		Dimensioni mm	Finitura	
602215		900 x 1800	bianco	1
602216			cemento	1
602217			antracite	1
602218			corda	1

CODICE	EURO/PZ	VERSIONE		PZ
		Dimensioni mm	Finitura	
602220		900 x 2000	bianco	1
602221			cemento	1
602222			antracite	1
602223			corda	1

## Piatto doccia ZERO - Grandi formati

CODICE	EURO/PZ	VERSIONE		PZ
		Dimensioni mm	Finitura	
602225		1000 x 1000	bianco	1
602226			cemento	1
602227			antracite	1
602228			corda	1

CODICE	EURO/PZ	VERSIONE		PZ
		Dimensioni mm	Finitura	
602235		1000 x 1200	bianco	1
602236			cemento	1
602237			antracite	1
602238			corda	1

CODICE	EURO/PZ	VERSIONE		PZ
		Dimensioni mm	Finitura	
602250		1000 x 1400	bianco	1
602251			cemento	1
602252			antracite	1
602253			corda	1

CODICE	EURO/PZ	VERSIONE		PZ
		Dimensioni mm	Finitura	
602260		1000 x 1600	bianco	1
602261			cemento	1
602262			antracite	1
602263			corda	1

CODICE	EURO/PZ	VERSIONE		PZ
		Dimensioni mm	Finitura	
602270		1000 x 1800	bianco	1
602271			cemento	1
602272			antracite	1
602273			corda	1

CODICE	EURO/PZ	VERSIONE		PZ
		Dimensioni mm	Finitura	
602280		1000 x 2000	bianco	1
602281			cemento	1
602282			antracite	1
602283			corda	1

CODICE	EURO/PZ	VERSIONE		PZ
		Dimensioni mm	Finitura	
602290		1000 x 2150	bianco	1
602291			cemento	1
602292			antracite	1
602293			corda	1

CODICE	EURO/PZ	VERSIONE		PZ
		Dimensioni mm	Finitura	
602295		1100 x 2000	bianco	1
602296			cemento	1
602297			antracite	1
602298			corda	1

# Piatto doccia ZERO - angolo tondo

PIATTO DOCCIA ANGOLO TONDO RAGGIO 55 CM

CODICE	EURO/PZ	VERSIONE		PZ
		Dimensioni mm	Finitura	
602315		900x900	bianco	1
602316			cemento	1
602317			antracite	1
602318			corda	1

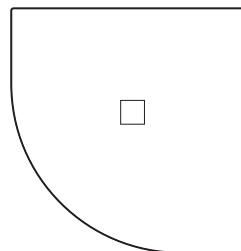

## Piatto doccia ZERO - Accessori e ricambi

CODICE	EURO/PZ	VERSIONE	Peso ml	PZ
603515		Mastice in poliuretano - color bianco	300	1
603516		Mastice in poliuretano - color cemento	300	1
603517		Mastice in poliuretano - color antracite	300	1
603518		Mastice in poliuretano - color corda	300	1
602325		Kit di ripristino - piccolo - color bianco	125	1
602326		Kit di ripristino - piccolo - color cemento	125	1
602327		Kit di ripristino - piccolo - color antracite	125	1
602328		Kit di ripristino - piccolo - color corda	125	1

CODICE	EURO/PZ	VERSIONE	PZ
606152		Piletta di scarico ribassata Ø 90 mm	1
602335		Griglia in inox	1

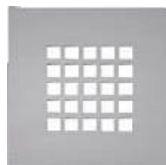

BIANCO

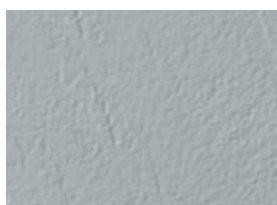

CEMENTO

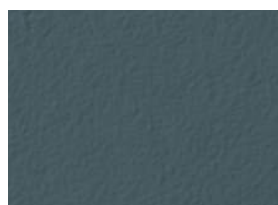

ANTRACITE

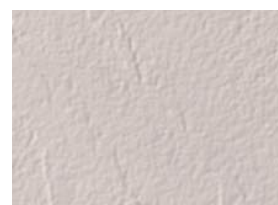

CORDA

# Canalette Linea Inox Style

Piccole, grandi, quadrate, sobrie. **Inox Style** offre una linea completa di canalette di scarico per doccia a filo pavimento. Grazie all'**altezza di soli 63 mm** sono particolarmente indicate nelle ristrutturazioni.

Interamente in acciaio inox con cornice specifica per un ottimo collegamento con la guaina, liquida o morbida, a garanzia di una totale impermeabilizzazione. Concepite per poter essere installate in posizione centrale o laterale rispetto al piatto doccia (**serie Luxury**) ma anche tra il piatto doccia e la parete (**serie Ram**).

<b>VANTAGGI</b>	<b>FACILE DA MONTARE</b>	<b>ANTIBATTERICO E ANTIMUFFA</b>	<b>ALTEZZA REGOLABILE</b>	<b>8 MISURE DISPONIBILI</b>	<b>8 GRIGLIE DISPONIBILI</b>	<b>RESISTE AI RAGGI UV</b>	<b>ADATTO A PERSONE CON DIFFICOLTÀ MOTORIE</b>

## Linea Luxury rettangolare e quadrata

Soluzioni di installazione: posizione centrale o laterale



### SOLUZIONI DI INSTALLAZIONE

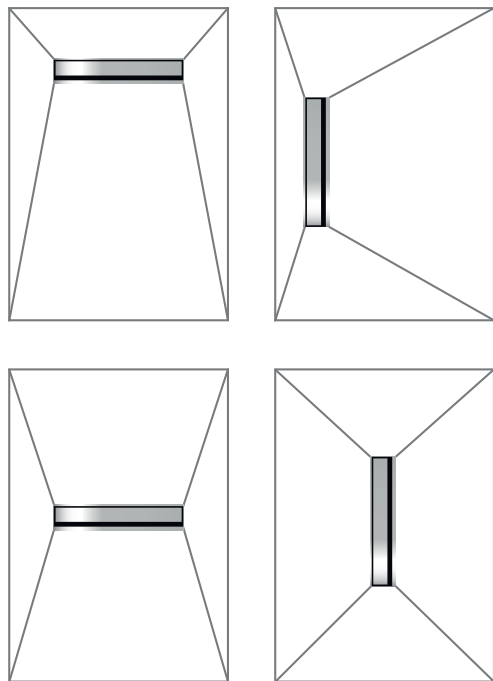

## Linea Ram rettangolare e triangolare

Soluzioni di installazione: filo muro (con scarico orizzontale)



### SOLUZIONI DI INSTALLAZIONE

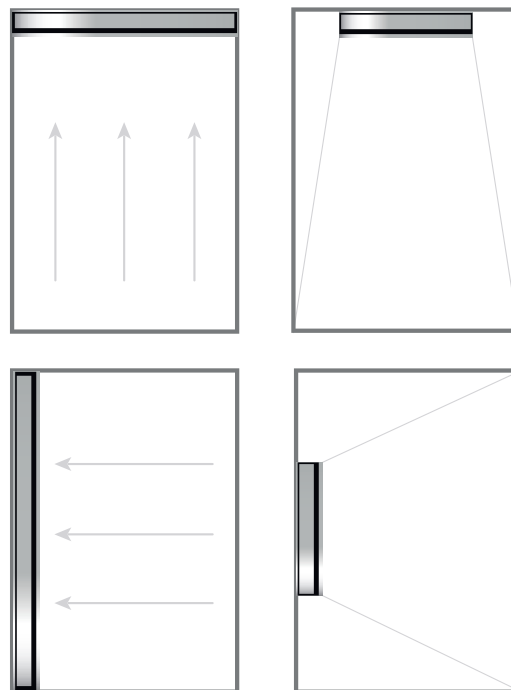

Sifone di scarico in acciaio inox incluso



**SIFONE ANTIODORE VALVE**  
Sifone antiodore in acciaio inox progettato con valvola automatica di chiusura contro la fuoriuscita di eventuali cattivi odori Cod. 606151

SISTEMA DI SCARICO INOX STYLE

## Linea Luxury Rettangolare

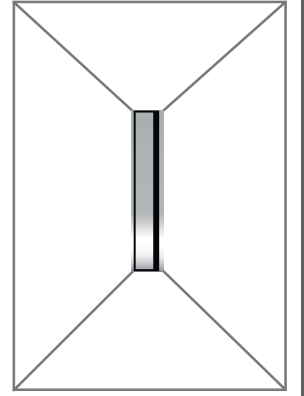
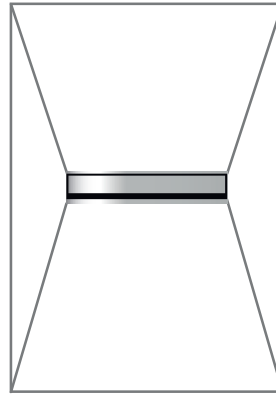
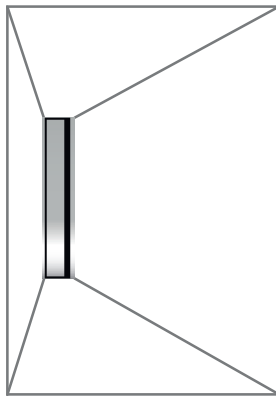
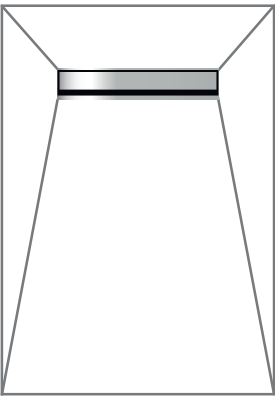

### Caratteristiche

Materiale	acciaio inox spessore 20/10
Scarico	DN 50
Capacità di scarico	55 l/min
Colore	acciaio
Dimenszioni	A 80 x H 63 ÷ 115 mm

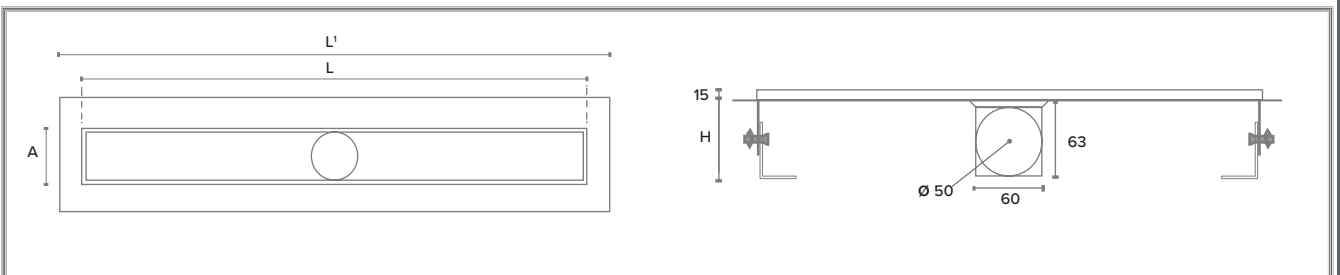

# Linea Luxury Rettangolare

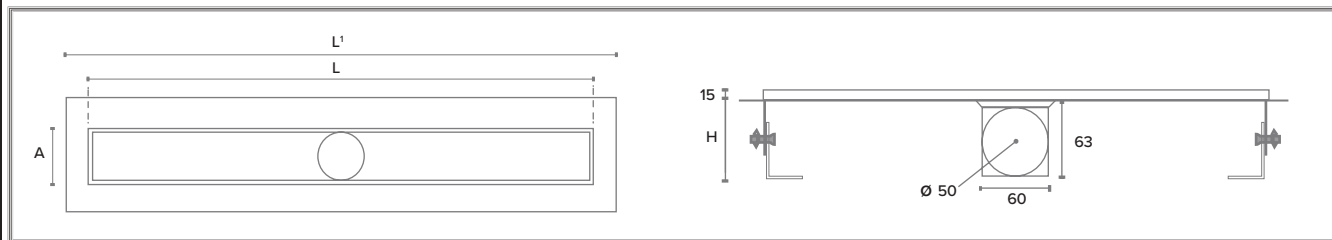

## FULL INOX PIASTRELLABILE

CODICE	EURO/PZ	VERSIONE		PZ
		L (mm)	L' (mm)	
603080		485	535	1
603081		585	635	1
603082		685	735	1
603083		785	835	1
603084		885	935	1
603085		985	1035	1
603086		1085	1135	1
603087		1185	1235	1



## FULL INOX LUCIDO



CODICE	EURO/PZ	VERSIONE		PZ
		L (mm)	L' (mm)	
603000		485	535	1
603001		585	635	1
603002		685	735	1
603003		785	835	1
603004		885	935	1
603005		985	1035	1
603006		1085	1135	1
603007		1185	1235	1

## FULL INOX SATINATO



CODICE	EURO/PZ	VERSIONE		PZ
		L (mm)	L' (mm)	
603008		485	535	1
603009		585	635	1
603010		685	735	1
603011		785	835	1
603012		885	935	1
603013		985	1035	1
603014		1085	1135	1
603015		1185	1235	1

## FULL INOX CON INCISIONE "SQUARE 1"



CODICE	EURO/PZ	VERSIONE		PZ
		L (mm)	L' (mm)	
603016		485	535	1
603017		585	635	1
603018		685	735	1
603019		785	835	1
603020		885	935	1
603021		985	1035	1
603022		1085	1135	1
603023		1185	1235	1

## FULL INOX CON INCISIONE "SQUARE 2"



CODICE	EURO/PZ	VERSIONE		PZ
		L (mm)	L' (mm)	
603024		485	535	1
603025		585	635	1
603026		685	735	1
603027		785	835	1
603028		885	935	1
603029		985	1035	1
603030		1085	1135	1
603031		1185	1235	1

**FULL INOX CON INCISIONE "RECTANGLES"**

CODICE	EURO/PZ	VERSIONE		PZ
		L (mm)	L <sup>1</sup> (mm)	
603032		485	535	1
603033		585	635	1
603034		685	735	1
603035		785	835	1
603036		885	935	1
603037		985	1035	1
603038		1085	1135	1
603039		1185	1235	1

**FULL INOX CON INCISIONE "CIRCLES"**

CODICE	EURO/PZ	VERSIONE		PZ
		L (mm)	L <sup>1</sup> (mm)	
603040		485	535	1
603041		585	635	1
603042		685	735	1
603043		785	835	1
603044		885	935	1
603045		985	1035	1
603046		1085	1135	1
603047		1185	1235	1

**FULL INOX CON LASTRA IN CRISTALLO BIANCO**

CODICE	EURO/PZ	VERSIONE		PZ
		L (mm)	L <sup>1</sup> (mm)	
603072		485	535	1
603073		585	635	1
603074		685	735	1
603075		785	835	1
603076		885	935	1
603077		985	1035	1
603078		1085	1135	1
603079		1185	1235	1

**FULL INOX CON LASTRA IN CRISTALLO NERO**

CODICE	EURO/PZ	VERSIONE		PZ
		L (mm)	L <sup>1</sup> (mm)	
603064		485	535	1
603065		585	635	1
603066		685	735	1
603067		785	835	1
603068		885	935	1
603069		985	1035	1
603070		1085	1135	1
603071		1185	1235	1

**FULL INOX CON INCISIONE "VENICE 1"**

CODICE	EURO/PZ	VERSIONE		PZ
		L (mm)	L <sup>1</sup> (mm)	
603048		485	535	1
603049		585	635	1
603050		685	735	1
603051		785	835	1
603052		885	935	1
603053		985	1035	1
603054		1085	1135	1
603055		1185	1235	1

**FULL INOX CON INCISIONE "VENICE 2"**

CODICE	EURO/PZ	VERSIONE		PZ
		L (mm)	L <sup>1</sup> (mm)	
603056		485	535	1
603057		585	635	1
603058		685	735	1
603059		785	835	1
603060		885	935	1
603061		985	1035	1
603062		1085	1135	1
603063		1185	1235	1

SISTEMA DI SCARICO INOX STYLE

# Linea RAM Rettangolare

Soluzioni di installazione: filo muro (con scarico orizzontale)

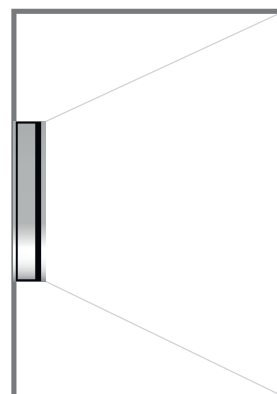
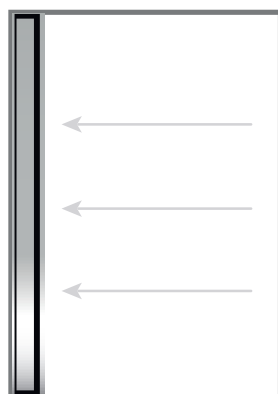
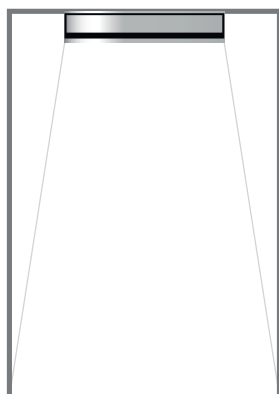
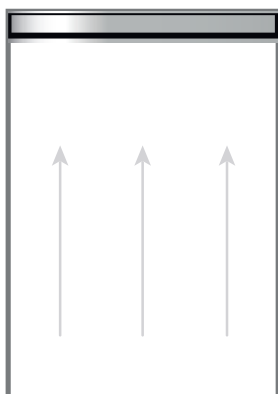

**Caratteristiche**

Materiale	acciaio inox spessore 20/10
Scarico	DN 50
Capacità di scarico	55 l/min
Colore	acciaio
Dimenszioni	A 80 mm x H 63 ÷ 115 mm

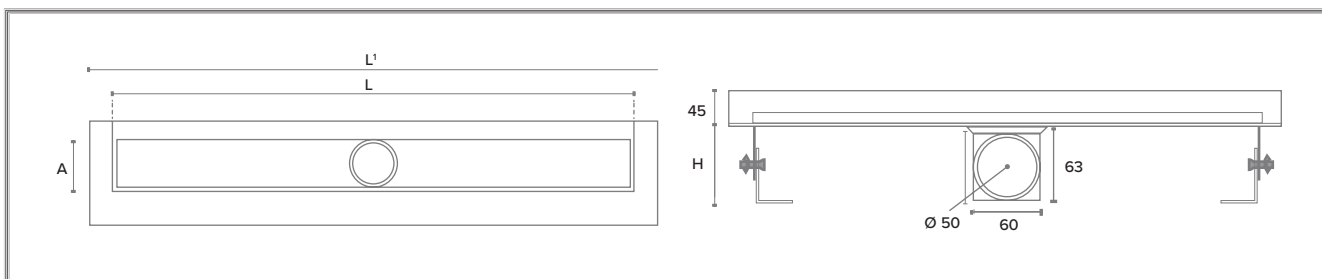

**FULL INOX LUCIDO**

CODICE	EURO/PZ	VERSIONE		PZ
		L (mm)	L <sup>1</sup> (mm)	
603300		485	535	1
603301		585	635	1
603302		685	735	1
603303		785	835	1
603304		885	935	1
603305		985	1035	1
603306		1085	1135	1
603307		1185	1235	1

**FULL INOX SATINATO**

CODICE	EURO/PZ	VERSIONE		PZ
		L (mm)	L <sup>1</sup> (mm)	
603308		485	535	1
603309		585	635	1
603310		685	735	1
603311		785	835	1
603312		885	935	1
603313		985	1035	1
603314		1085	1135	1
603315		1185	1235	1

**FULL INOX PIASTRELLABILE**

CODICE	EURO/PZ	VERSIONE		PZ
		L (mm)	L <sup>1</sup> (mm)	
603380		485	535	1
603381		585	635	1
603382		685	735	1
603383		785	835	1
603384		885	935	1
603385		985	1035	1
603386		1085	1135	1
603387		1185	1235	1

**FULL INOX CON INCISIONE "SQUARE 1"**

CODICE	EURO/PZ	VERSIONE		PZ
		L (mm)	L <sup>1</sup> (mm)	
603316		485	535	1
603317		585	635	1
603318		685	735	1
603319		785	835	1
603320		885	935	1
603321		985	1035	1
603322		1085	1135	1
603323		1185	1235	1

**FULL INOX CON LASTRA IN CRISTALLO BIANCO**



CODICE	EURO/PZ	VERSIONE		PZ
		L (mm)	L <sup>1</sup> (mm)	
603372		485	535	1
603373		585	635	1
603374		685	735	1
603375		785	835	1
603376		885	935	1
603377		985	1035	1
603378		1085	1135	1
603379		1185	1235	1

**FULL INOX CON LASTRA IN CRISTALLO NERO**

CODICE	EURO/PZ	VERSIONE		PZ
		L (mm)	L <sup>1</sup> (mm)	
603364		485	535	1
603365		585	635	1
603366		685	735	1
603367		785	835	1
603368		885	935	1
603369		985	1035	1
603370		1085	1135	1
603371		1185	1235	1

**Linea LUXURY  
Quadrata**

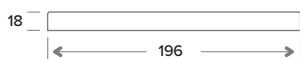
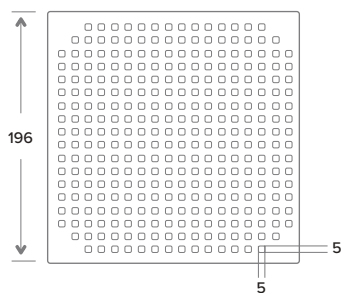
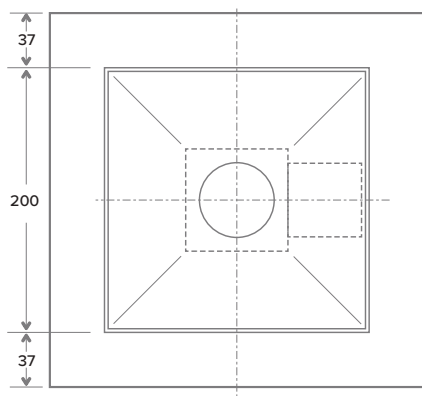
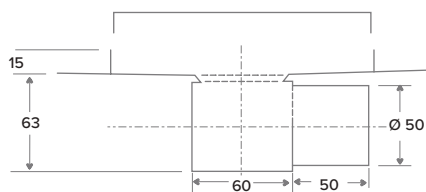
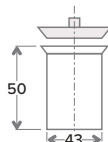
**FULL INOX CON INCISIONE "SQUARES 1"  
200 X 200**



**Caratteristiche**

Materiale	acciaio inox spessore 20/10
Scarico	DN 50
Capacità di scarico	55 l/min
Colore	acciaio
Dimensioni	A 200 x L 200 x H 63 mm

CODICE	EURO/PZ	PZ
603090		1

**FULL INOX PIASTRELLABILE  
200 X 200**

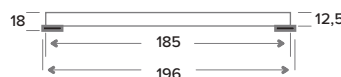
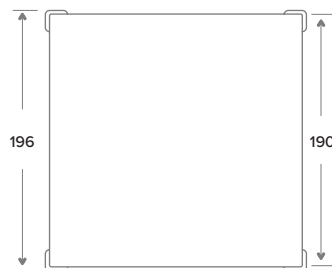
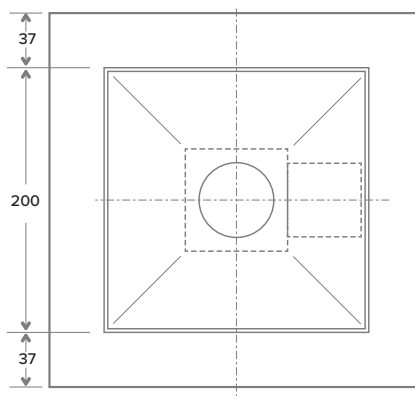
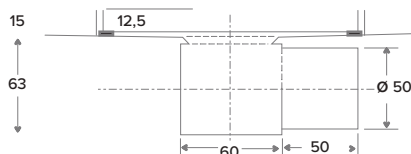
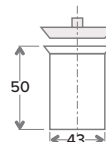

**Caratteristiche**

Materiale	acciaio inox spessore 20/10
Scarico	DN 50
Capacità di scarico	55 l/min
Colore	acciaio
Dimensioni	A 200 x L 200 x H 63 mm

CODICE	EURO/PZ	PZ
603091		1

# Linea RAM Triangolare

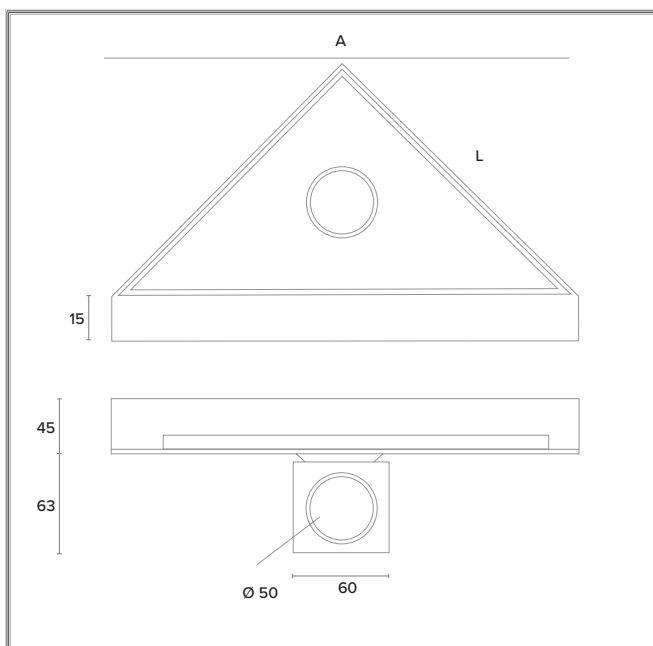

### Caratteristiche

Materiale	acciaio inox spessore 20/10
Colore	acciaio
Dimensioni	A 226 x L 315 x H 63 mm

### FULL INOX CON INCISIONE "CIRCLES"



CODICE	EURO/PZ	PZ
603390		1

### FULL INOX PIASTRELLABILE



CODICE	EURO/PZ	PZ
603391		1

SISTEMA DI SCARICO INOX STYLE

**Chiusino sifonato  
LINEA LUXURY  
Quadrata**

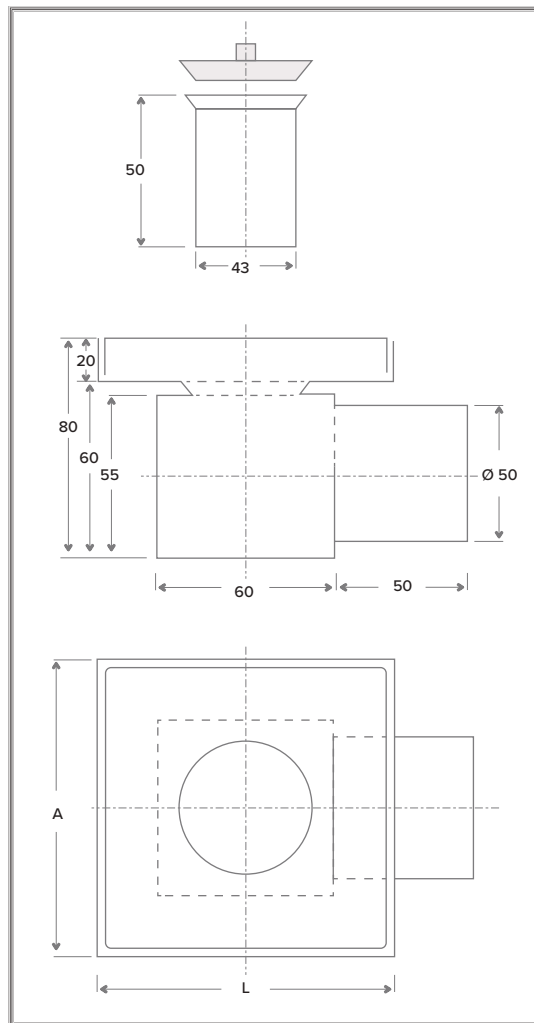

**Caratteristiche**

Materiale	acciaio inox spessore 20/10
Scarico	DN 50
Capacità di scarico	55 l/min
Colore	acciaio
Dimensioni	A 100 x L 100 x H 63 mm



**FULL INOX CON LASTRA PIASTRELLABILE**

CODICE	EURO/PZ	PZ
603116		1

**FULL INOX CON INCISIONE  
100 X 100**

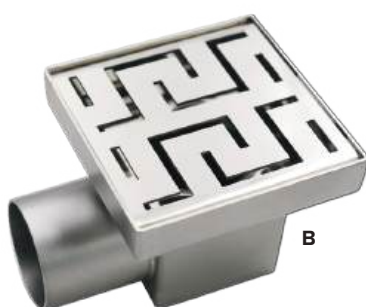

CODICE	EURO/PZ	VERSIONE	PZ
		□ Incisione	
603110		A Rectangles	1
603112		B Venice2	1
603114		C Square1	1

## SISTEMA DI SCARICO PER DOCCIA INOX SLOT

La funzionalità nella sua forma più elegante e moderna racchiusa in una semplice fessura. Minimale, semplice e pulita la linea INOX SLOT è stata progettata in ogni minimo particolare per non dover scendere a compromessi tra funzionalità e design. Tutti i modelli della linea INOX SLOT sono studiati in ogni minimo particolare e possono essere agevolmente tagliati su misura direttamente in loco.

**VANTAGGI**

**SEZIONABILE IN  
OPERA**

**ANTIBATTERICO  
E ANTIMUFFA**

**ALTEZZA  
REGOLABILE**

**ADATTO A PERSONE CON  
DIFFICOLTÀ MOTORIE**

### INOX SLOT FLOOR

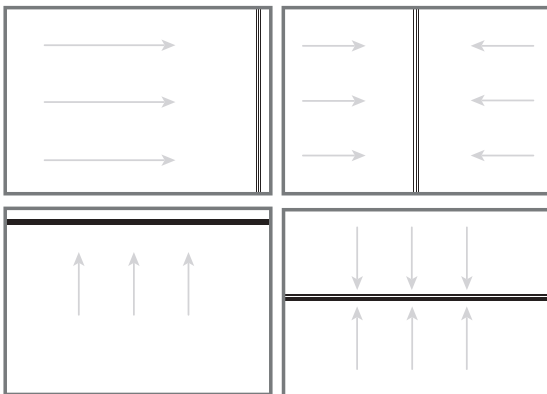

### INOX SLOT WALL

Installazione a parete (con scarico verticale)

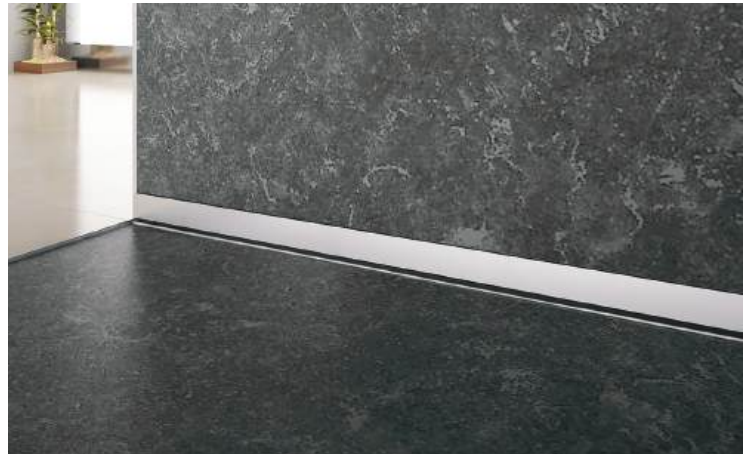
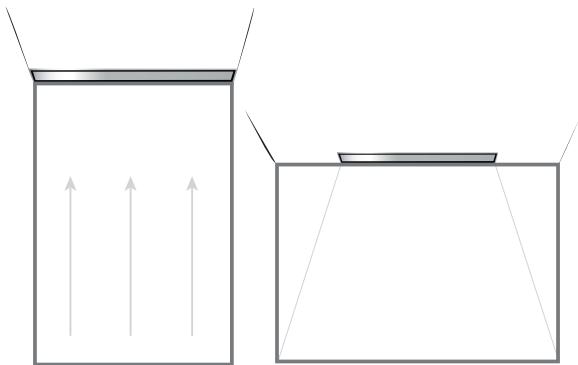

### INOX SLOT FLOOR 2DS

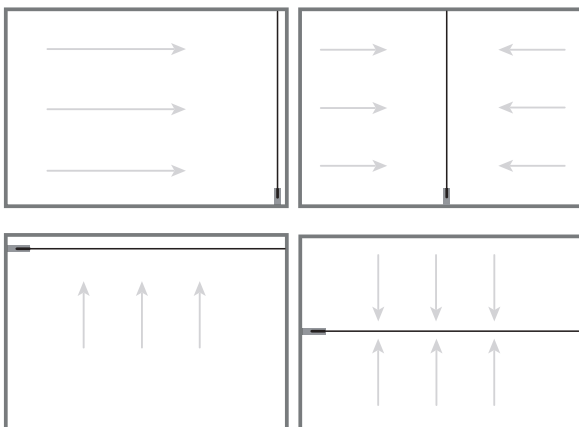

**SISTEMA DI SCARICO PER DOCCIA  
INOX SLOT FLOOR  
sezionabile in opera**

**Caratteristiche**

Materiale	acciaio inox
Scarico	DN 50
Capacità di scarico	55 l/min
Colore	acciaio
Regolazione supporto griglia	H 12 ÷ 24 mm
Altezza regolabile	64 ÷ 90 mm
Lunghezza	1000 mm

**DI SERIE (INCLUSI) - confezione unica**



**MODULO AD INCASSO** corredato di guaina e piedini di ancoraggio regolabili in altezza



**Supporto della griglia regolabile in altezza** da 12 a 24 mm



**Progettati per essere sezionati su misura in opera**



**SIFONE DI SCARICO** ribassato orientabile



**SUPPORTO PER GRIGLIA IN REGOLABILE**

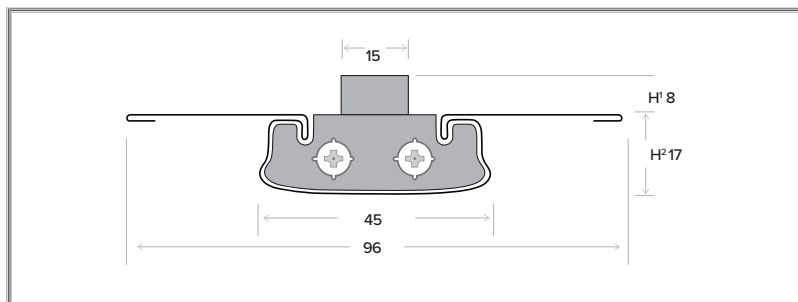
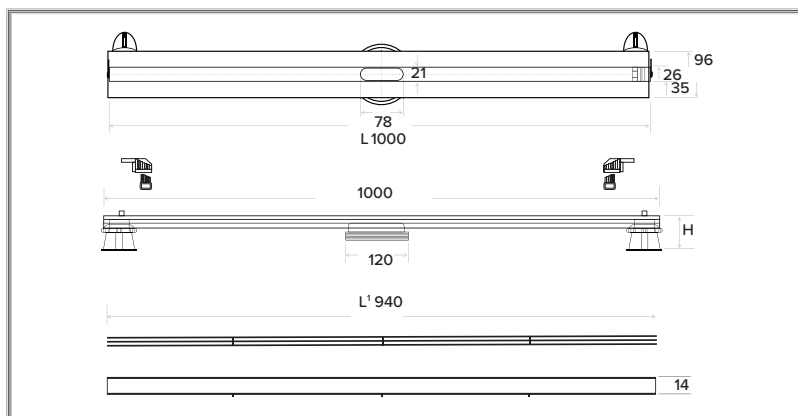

CODICE	EURO/PZ	VERSIONE					PZ
		L (mm)	L¹ (mm)	H	H¹ (mm)	H² (mm)	
603411		1000	940	64 ÷ 90	8	17	1



## SISTEMA DI SCARICO PER DOCCIA INOX SLOT WALL

sezionabile in opera

Installazione a parete (con scarico verticale)

### Caratteristiche

Materiale	acciaio inox
Scarico	DN 50
Capacità di scarico	55 l/min
Colore	acciaio satinato
Altezza regolabile	60 ÷ 125 mm
Lunghezza	1000 mm

DI SERIE (INCLUSI) - confezione unica



MODULO AD INCASSO corredato di guaina e piedini di ancoraggio regolabili in altezza



SUPPORTO PER GRIGLIA IN ACCIAIO INOX tagliabile su misura in opera

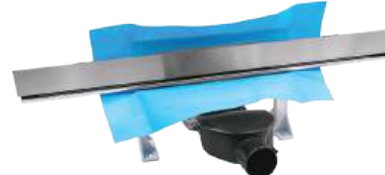

GRIGLIA IN ACCIAIO INOX tagliabile su misura in opera e rimovibile



GRIGLIA FERMA CAPELLI in acciaio inox



SIFONE DI SCARICO ribassato orientabile

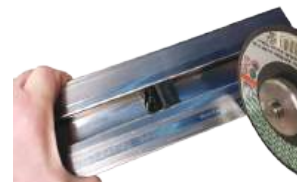

Progettati per essere sezionati su misura in opera

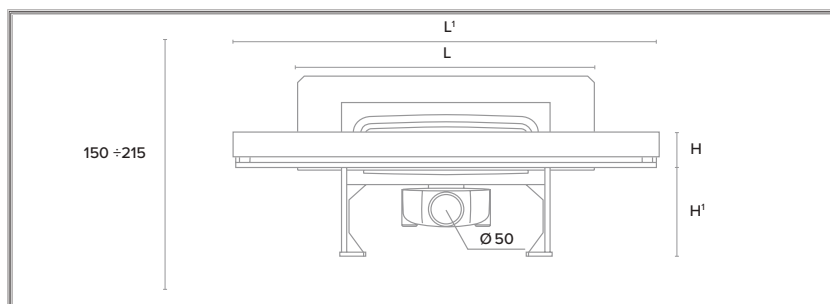
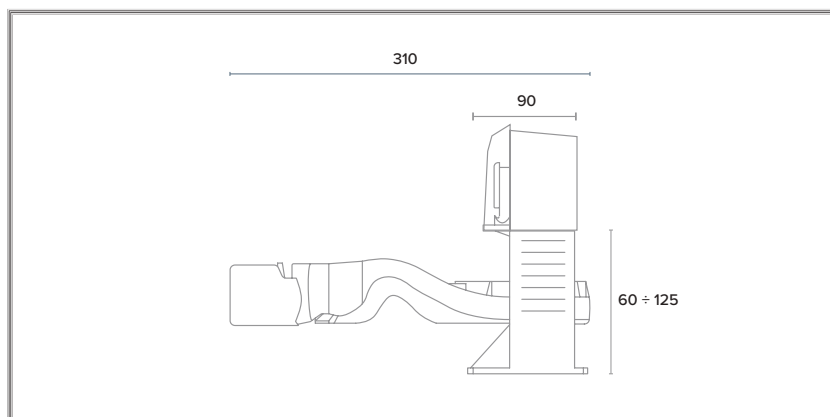

CODICE	EURO/PZ	VERSIONE				PZ
		L (mm)	L' (mm)	H (mm)	H' (mm)	
603401		295	1000	40	60 ÷ 125	1

**SISTEMA DI SCARICO PER DOCCIA**  
**INOX SLOT FLOOR 2DS**  
 (reversibile)

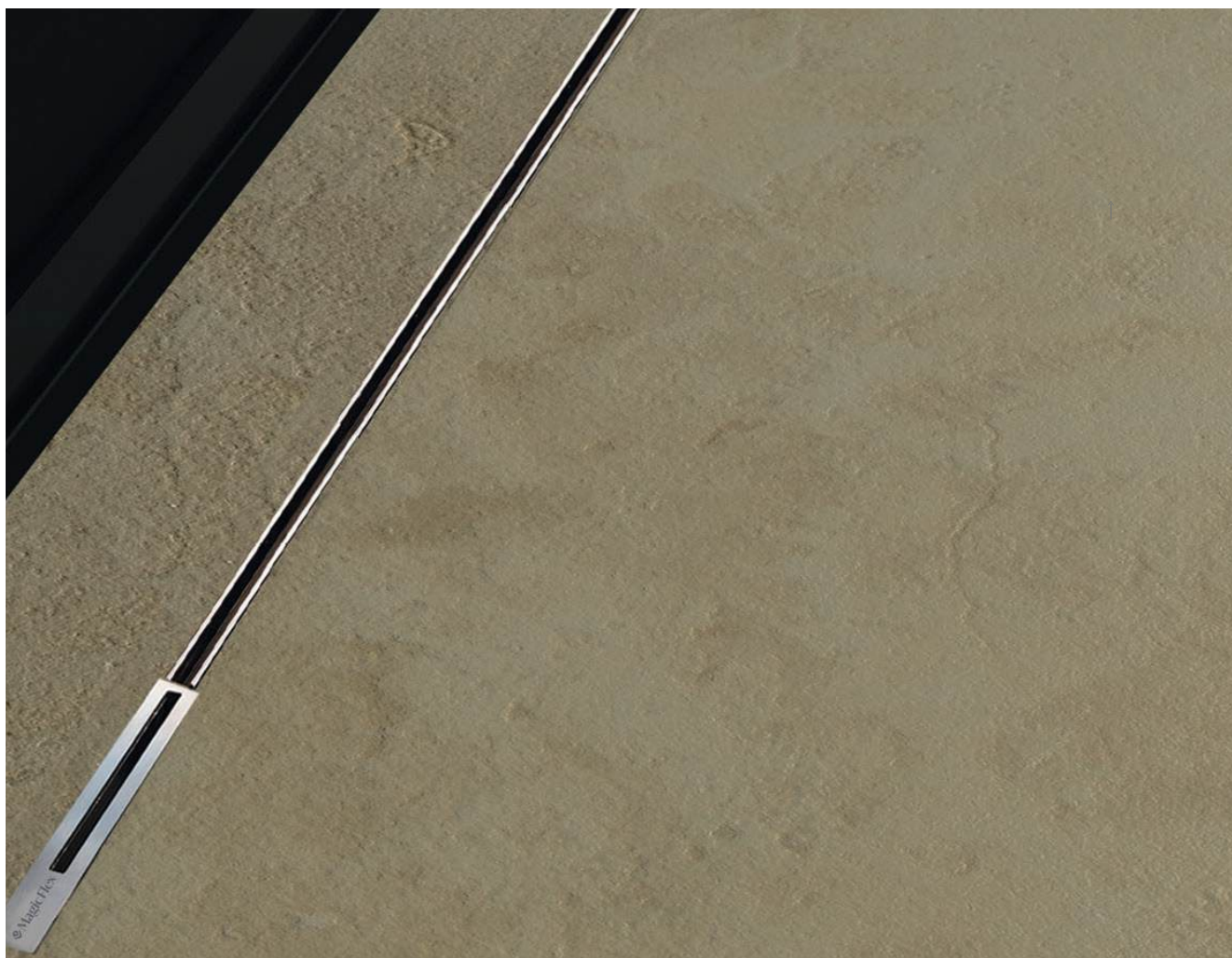

**Caratteristiche**

Materiale	acciaio inox
Scarico	DN 50
Capacità di scarico	55 l/min
Colore	acciaio
Altezza regolabile	64 ÷ 90 mm
Lunghezza	2000 mm



Possono essere agevolmente tagliati su misura direttamente in opera

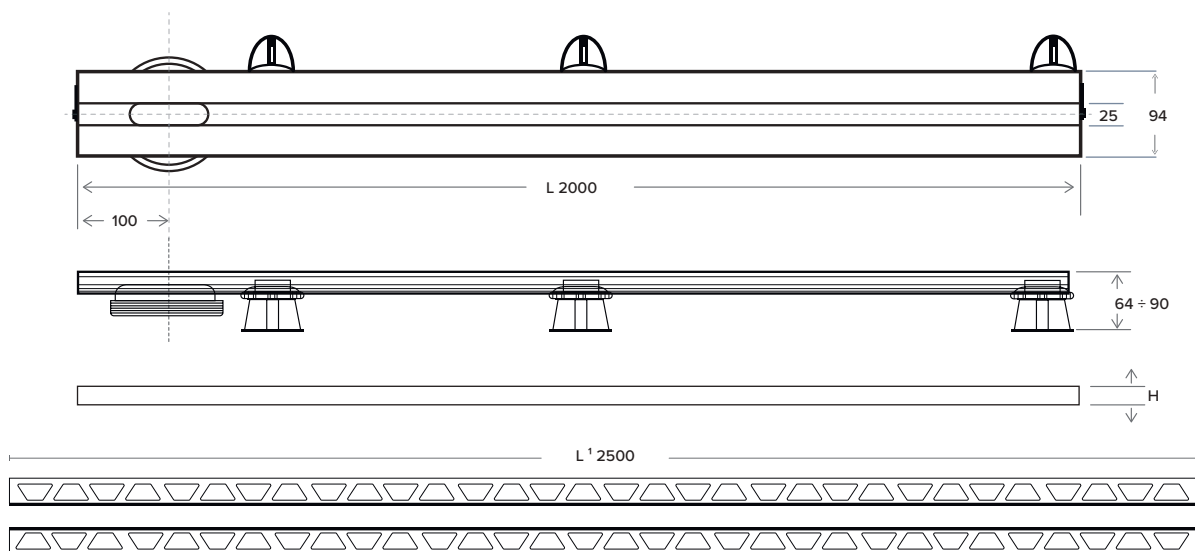



**Composto da:**

- Modulo ad incasso corredato di guaina e piedini di ancoraggio regolabili in altezza
- Sifone di scarico ribassato orientabile
- Griglia ferma capelli in acciaio inox
- Profili per rivestimento ceramico (vedi versione)

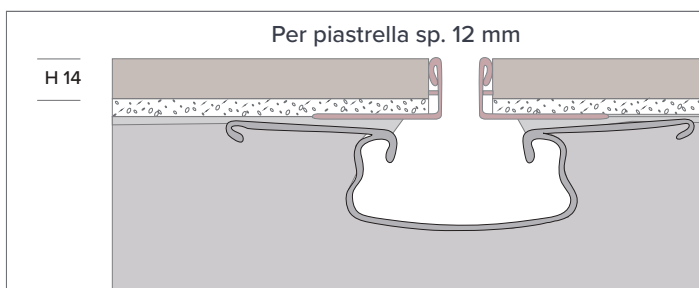
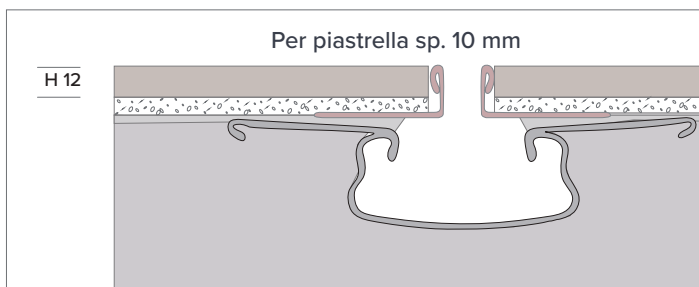
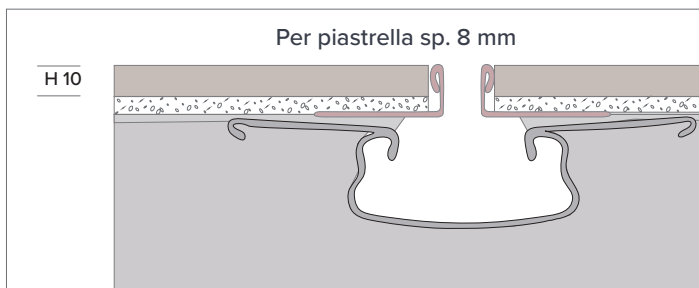
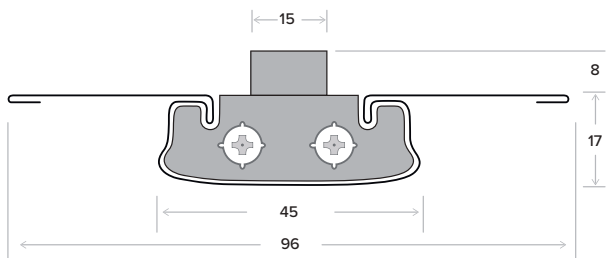

Griglia di ispezione

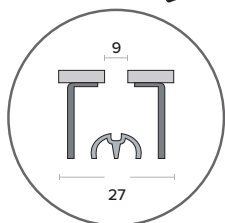

CODICE	EURO/PZ	VERSIONE		PZ
		L (mm)	H (mm)	
603415		2000	10	1
603416			12	1
603417			14	1

**PROFILI DI RICAMBIO IN ACCIAIO INOX**

CODICE	EURO/PZ	VERSIONE		PZ.
		L' (mm)	H' (mm)	
603500		2500	10 per piastrella sp. 8	1
603501			12 per piastrella sp. 10	1
603502			14 per piastrella sp. 12	1

**FLESSIBILI DOCCIA  
SPRING LINE**

Unico sul mercato per la novità, per il design e per i materiali utilizzati



Realizzato in filo di acciaio inox AISI 304 di diametro 1 mm elettrolucidato e lavorato artigianalmente per ottenere quel particolare effetto cromatico. Per realizzare un flessibile doccia da un metro e mezzo vengono utilizzati 78 metri di filo di acciaio. Prodotto coperto da brevetto. Maglia non estensibile.

**Caratteristiche**

Materiale	acciaio inox AISI 304
Colore maglia	Cromo
Finiture terminali	ottone cromato liscio

**Caratteristiche**

Calotta	piana liscia
Cono	liscio
Attacchi	Ø 1/2 F



CODICE	EURO/PZ	VERSIONE	PZ
		L cm	
070620		120	1
070621		150	1
070622		175	1
070623		200	1

*Maglia non estensibile*



**Caratteristiche**

Calotta	piana liscia
Cono	liscio antitorsione
Attacchi	Ø 1/2 F



CODICE	EURO/PZ	VERSIONE	PZ
		L cm	
070627		120	1
070625		150	1
070628		175	1
070626		200	1

**Caratteristiche**

Cono	Ø 1/2 F antitorsione
Attacco	girevole 15 x 1 M



CODICE	EURO/PZ	VERSIONE	PZ
		L cm	
070630		120	1
070631		150	1
070632		175	1
070633		200	1

**Caratteristiche**

Cono	liscio
Cono	liscio antitorsione
Attacchi	Ø 1/2 F



CODICE	EURO/PZ	VERSIONE	PZ
		L cm	
070627CC		120	1
070625CC		150	1
070628CC		175	1
070626CC		200	1

**Caratteristiche**

Cono	Ø 1/2 F liscio
Attacco	girevole 15 x 1 M



CODICE	EURO/PZ	VERSIONE	PZ
		L cm	
070635		120	1
070636		150	1
070637		175	1
070638		200	1

# FLESSIBILI DOCCIA SIMPLE LINE

Pratico, semplice, funzionale

## ROUND PVC

### Caratteristiche

Materiale	PVC rinforzato
Sezione	circolare
Colore	argento
Finitura terminale	ottone cromato
Cono	Ø 1/2 F antitorsione
Attacco	Ø 1/2 F

CODICE	EURO/PZ	VERSIONE L cm	PZ
604300		120	1
604301		150	1
604302		200	1



## SQUARE PVC

### Caratteristiche

Materiale	PVC rinforzato
Sezione	quadrata
Colore	argento
Finitura terminale	ottone cromato
Cono	Ø 1/2 F antitorsione
Attacco	Ø 1/2 F

CODICE	EURO/PZ	VERSIONE L cm	PZ
604310		120	1
604311		150	1
604312		200	1



## STEEL

### Caratteristiche

Materiale	acciaio doppia aggraffatura
Colore	argento
Finitura terminale	ottone cromato
Cono	Ø 1/2 F antitorsione
Calotta	Ø 1/2 F

CODICE	EURO/PZ	VERSIONE L cm	PZ
604319		120	1
604320		150	1
604321		200	1





SALISCENDI  
**WHITE SUN**

Composto da:

- Asta in acciaio inox
- Supporto in ABS
- Scorrevole in ABS
- Porta oggetti
- Doccetta white Ø 150 mm a 5 funzioni
- Finitura cromo lucido/bianco
- Flessibile Linea SIMPLE L 150 cm acciaio inox doppia aggraffatura

CODICE	EURO/PZ	VERSIONE	PZ
		Dimensioni L x H mm	
<b>605100</b>		255 x 800	1



SALISCENDI  
**BLACK SUN**

Composto da:

- Asta in acciaio inox
- Supporto in ABS regolabile
- Scorrevole in ABS
- Doccetta white Ø 105 mm a 5 funzioni
- Finitura cromo lucido/nero
- Flessibile Linea SIMPLE L 150 cm acciaio inox doppia aggraffatura

CODICE	EURO/PZ	VERSIONE	PZ
		Dimensioni L x H mm	
<b>605102</b>		160 x 735	1

**KIT DOCCIA  
STEEL ROUND**

**Composto da:**

- Presa acqua a muro round in ottone cromato con supporto
- Braccio doccia round in ottone cromato Ø 22 x L 350 mm
- Soffione ultrapiatto round in acciaio inox AISI304
- Doccetta ispezionabile round in ottone cromato Ø 21 x L 196 mm
- Flessibile L. 150 cm (vedi pag. 38-39)

CODICE	EURO/PZ	VERSIONE		PZ
		Soffione Ø mm	Flessibile	
605201		200	Spring Line	1
605203		250		1
605205		300		1
605200		200	Round PVC	1
605202		250		1
605204		300		1

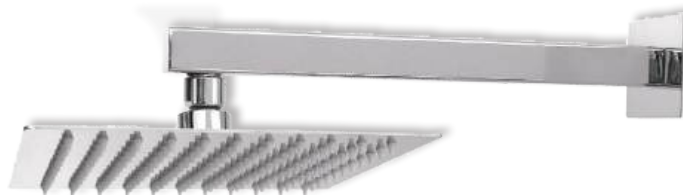
**KIT DOCCIA  
STEEL SQUARE**

**Composto da:**

- Presa acqua a muro square in ottone cromato scomponibile con supporto
- Braccio doccia square in ottone cromato 250 x 250 x L 350 mm
- Soffione ultrapiatto square in acciaio inox AISI 304
- Doccetta square in ottone cromato L 35 x P 15 x H 230 mm
- Flessibile L 150 cm (vedi pag. 38-39)

CODICE	EURO/PZ	VERSIONE		PZ
		Soffione □ mm	Flessibile	
605207		200x200	Spring Line	1
605209		250x250		1
605211		300x300		1
605206		200x200	Square PVC	1
605208		250x250		1
605210		300x300		1



## KIT DOCCIA DUPLEX ROUND



### Composto da:

- Presa acqua a muro con supporto round
- Flessibile L. 150 cm (vedi pag. 38-39)

### Con doccetta in OTTONE ispezionabile

CODICE	EURO/PZ	Flessibile	Doccetta Round mm	PZ
		Simple Steel	Ø 21 x L 196	1
605222		Spring Line		1
605223		Simple Round		1

### Con doccetta in ABS

CODICE	EURO/PZ	Flessibile	Doccetta Round mm	PZ
		Simple Steel	Ø 32 x L 200	1
605232		Spring Line		1
605233		Simple Round		1

## KIT DOCCIA DUPLEX ROUND CON VALVOLA DI SICUREZZA



### Composto da:

- Presa acqua a muro round in ottone cromato con supporto e valvola di sicurezza
- Flessibile L. 150 cm (vedi pag. 38-39)

### Con doccetta in OTTONE

CODICE	EURO/PZ	VERSIONE	Doccetta Round mm	PZ
		Flessibile	Ø 21 x L 196	
		Simple Steel		1
605266		Spring Line		1
605267		Simple Round	1	

### Con doccetta in ABS

CODICE	EURO/PZ	VERSIONE	Doccetta Round mm	PZ
		Flessibile	Ø 32 x L 200	
		Simple Steel		1
605260		Spring Line		1
605261		Simple Round	1	

## KIT DOCCIA DUPLEX SQUARE

### Composto da:

- Presa acqua a muro scomponibile in ottone comato con supporto square
- Flessibile L. 150 cm (vedi pag. 38-39)



### Con doccetta in OTTONE

CODICE	EURO/PZ	VERSIONE		PZ
		Flessibile	Doccetta Square mm	
605227		Simple Steel	L 35 x P 15 x L 196	1
605228		Spring Line		1
605231		Simple Square		1

### Con doccetta in ABS

CODICE	EURO/PZ	VERSIONE		PZ
		Flessibile	Doccetta Square in ABS	
605235		Simple Steel	L 35 x P 15 x L 196	1
605236		Spring Line		1
605237		Simple Square		1

## KIT DOCCIA DUPLEX SQUARE CON VALVOLA DI SICUREZZA

### Composto da:

- Presa acqua a muro scomponibile square in ottone cromato con supporto e valvola di sicurezza
- Flessibile L. 150 cm (vedi pag. 38-39)

### Con doccetta in OTTONE

CODICE	EURO/PZ	VERSIONE		PZ
		Flessibile	Doccetta Square mm	
605269		Simple Steel	L 35 x P 15 x L 200	1
605270		Spring Line		1
605271		Simple Square		1

### Con doccetta in ABS

CODICE	EURO/PZ	VERSIONE		PZ
		Flessibile	Doccetta Square mm	
605263		Simple Steel	L 35 x P 15 x L 200	1
605264		Spring Line		1
605265		Simple Square		1



KIT SHUT - OFF  
**ROUND CLASSIC**  
SALVASPAZIO

Doccetta shut-off  
con pulsante  
ON/OFF



Pres a acqua a  
muro con attacco  
doccetta

**Caratteristiche**

Pres a muro | ottone cromato  
Doccetta | ottone cromato - L 140 x Ø 50 mm  
Flessibile | PVC grigio - 120 cm



Flessibile Simple Line  
ROUND

CODICE	EURO/PZ	PZ
605244		1

KIT SHUT - OFF  
**SQUARE CLASSIC**  
SALVASPAZIO

Doccetta shut-off con  
pulsante ON/OFF



Pres a acqua a muro  
con attacco doccetta

**Caratteristiche**

Pres a muro | ottone cromato  
Doccetta | ottone cromato - L 140 x Ø 50 mm  
Flessibile | PVC grigio - 120 cm



Flessibile Simple Line  
SQUARE

CODICE	EURO/PZ	PZ
605248		1

KIT SHUT - OFF  
**ROUND FAST**  
PER RUBINETTO BIDET

Doccetta shut-off con  
pulsante ON/OFF



**Caratteristiche**

Deviatore attacco rubinetto | ottone cromato M22 x 1 - M24 x 1  
Doccetta shut-off | ottone cromato L 140 x Ø 50 mm  
Supporto doccetta a muro | ottone cromato  
Attacco rubinetto | F22 x 1  
Flessibile | PVC grigio - 120 cm



Deviatore di flusso per  
rubinetto

CODICE	EURO/PZ	PZ
605254		1

### KIT SHUT - OFF ROUND ELEGANT



Flessibile Simple Line  
ROUND

#### Caratteristiche

Pres a muro | ottone cromato  
Doccetta | ottone cromato - L 140 x Ø 50 mm  
Flessibile | PVC grigio - 120 cm



CODICE	EURO/PZ	PZ
605251		1

### KIT SHUT - OFF SQUARE ELEGANT



Flessibile Simple Line  
SQUARE

#### Caratteristiche

Pres a muro | ottone cromato  
Doccetta | ottone cromato - L 140 x Ø 50 mm  
Flessibile | PVC grigio - 120 cm



CODICE	EURO/PZ	PZ
605253		1

### KIT IDROSCOPINO ROUND ELEGANT



Flessibile Simple Line  
ROUND

#### Caratteristiche

Pres a muro | ottone cromato  
Doccetta | ottone cromato - L 140 x Ø 50 mm  
Flessibile | PVC grigio - 120 cm

Doccetta idroscopino  
con pulsante  
a rilascio



CODICE	EURO/PZ	PZ
605250		1

### KIT IDROSCOPINO SQUARE ELEGANT



Flessibile Simple Line  
SQUARE

#### Caratteristiche

Pres a muro | ottone cromato  
Doccetta | ottone cromato - L 140 x Ø 50 mm  
Flessibile | PVC grigio - 120 cm

Doccetta  
idroscopino con  
pulsante a rilascio

Pres a acqua a  
muro con attacco  
idroscopino  
e chiusura di  
sicurezza



CODICE	EURO/PZ	PZ
605252		1

SOFFIONI DOCCIA  
**LOW ROUND**  
IN ACCIAIO INOX



Soffione utrapiatto round in acciaio inox  
Ugelli in silicone anticalcare autopulenti

**Caratteristiche**

Conforme	DM 174
Materiale	acciaio inox AISI 304
Spessore	2 mm
Attacco	1/2" F
Finitura	lucida

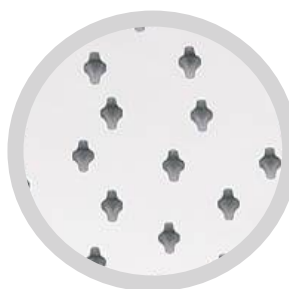

CODICE	EURO/PZ	VERSIONE		PZ
		Soffione Ø mm	Ugelli n°	
605400		100	33	1
605401		150	44	1
605402		200	90	1
605403		250	126	1
605404		300	156	1

BRACCIO DOCCIA  
**ROUND**

**Caratteristiche**

Materiale	acciaio inox AISI 304
Attacco	1/2" M
Finitura	lucida



**PER INSTALLAZIONE A PARETE**

CODICE	EURO/PZ	VERSIONE	PZ
		Ø x L mm	
605306		22 x 300	1
605307		22 x 350	1
605308		22 x 400	1

**PER INSTALLAZIONE A SOFFITTO**

CODICE	EURO/PZ	VERSIONE	PZ
		Ø x L mm	
605300		22 x 100	1
605301		22 x 200	1
605302		22 x 300	1

## SOFFIONI DOCCIA LOW SQUARE IN ACCIAIO INOX

Soffione utrapiatto square in acciaio inox  
Ugelli in silicone anticalcare autopulenti

### Caratteristiche

Conforme	DM 174
Materiale	acciaio inox AISI 304
Spessore	2 mm
Attacco	1/2" F
Finitura	lucida

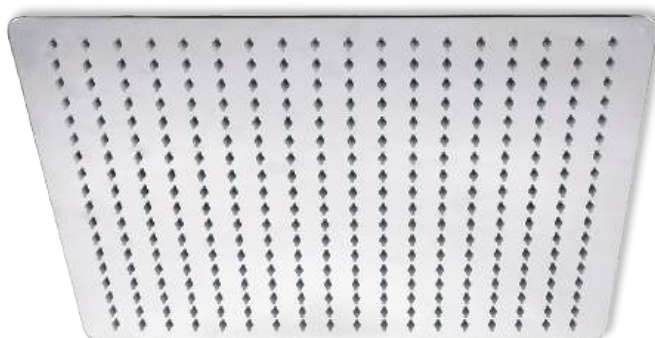
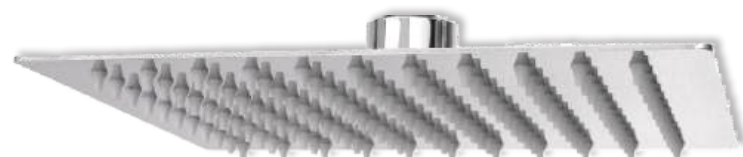
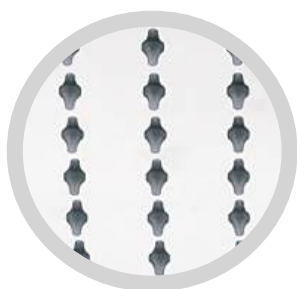

CODICE	EURO/PZ	VERSIONE		PZ
		Soffione L x L mm	Ugelli n°	
605410		100x 100	36	1
605411		150x 150	64	1
605412		200x 200	121	1
605414		250x 250	196	1
605415		300x 300	196	1
605413		200 x 300	196	1

## BRACCIO DOCCIA SQUARE

### Caratteristiche

Materiale	acciaio inox AISI 304
Attacco	1/2" M
Finitura	lucida

### PER INSTALLAZIONE A PARETE

CODICE	EURO/PZ	VERSIONE	PZ
		□ x L mm	
605309		25 x 300	1
605310		25 x 350	1
605311		25 x 400	1



### PER INSTALLAZIONE A SOFFITTO

CODICE	EURO/PZ	VERSIONE	PZ
		□ x L mm	
605303		25 x 100	1
605304		25 x 200	1
605305		25 x 300	1



**DOCCETTA ROUND  
MONOGETTO IN ABS**



**Caratteristiche**

Materiale	ABS anticalcare
Dimensioni	Ø 32 x L 200 mm
Attacco	1/2" M
Finitura	cromo lucida

CODICE	EURO/PZ	PZ
605518		1

**DOCCETTA SQUARE  
MONOGETTO IN ABS**



**Caratteristiche**

Materiale	ABS anticalcare
Dimensioni	□ 25 x L 210 mm
Attacco	1/2" M
Finitura	cromo lucida

CODICE	EURO/PZ	PZ
605520		1

**DOCCETTA ROUND  
MONOGETTO CROMO**

Scomponibile ed  
ispezionabile



**Caratteristiche**

Materiale	ottone cromato
Dimensioni	Ø 21 x L 200 mm
Attacco	1/2" M
Finitura	cromo lucida

CODICE	EURO/PZ	PZ
605500		1

**DOCCETTA SQUARE  
MONOGETTO CROMO**



**Caratteristiche**

Materiale	ottone cromato
Dimensioni	□ 35 x 15 x L 230 mm
Attacco	1/2" M
Finitura	cromo lucida

CODICE	EURO/PZ	PZ
605501		1

**DOCCETTA LOW ROUND  
MONOGETTO**



**Caratteristiche**

Materiale	ottone cromato
Dimensioni	Ø 100 x L 232 mm
Attacco	1/2" M
Finitura	cromo lucida
Ugelli n°	33

CODICE	EURO/PZ	PZ
605502		1

**DOCCETTA LOW SQUARE  
MONOGETTO**



**Caratteristiche**

Materiale	ottone cromato
Dimensioni	□ 10 x 8 x L 232 mm
Attacco	1/2" M
Finitura	cromo lucida
Ugelli n°	30

CODICE	EURO/PZ	PZ
605503		1



### DOCCETTA 5 GETTI



#### Caratteristiche

Materiale ABS anticalcare  
 Dimensioni Ø 120 mm  
 Attacco 1/2" M  
 Finitura cromo lucida

CODICE	EURO/PZ	PZ
605516		1

### DOCCETTA MONOGETTO



#### Caratteristiche

Materiale ABS anticalcare  
 Dimensioni Ø 70 mm  
 Attacco 1/2" M  
 Finitura cromo lucida

CODICE	EURO/PZ	PZ
605521		1

### DOCCETTA 3 GETTI



#### Caratteristiche

Materiale ABS anticalcare  
 Dimensioni Ø 120 mm  
 Attacco 1/2" M  
 Finitura nero/cromo

CODICE	EURO/PZ	PZ
605515		1

### DOCCETTA MONOGETTO



#### Caratteristiche

Materiale ABS anticalcare  
 Dimensioni □ 35 x 15 x L 230 mm  
 Attacco 1/2" M  
 Finitura cromo lucida

CODICE	EURO/PZ	PZ
605519		1

### DOCCETTA SHUT-OFF

Con pulsante ON / OFF



#### ROUND

CODICE	EURO/PZ	VERSIONE	PZ
		Dimensioni Ø x H x L mm	
605504		20 x 55 x 120	1

#### Caratteristiche

Materiale ottone cromato  
 Attacco 1/2" M  
 Finitura cromo lucida

Con pulsante di azionamento



#### SQUARE

CODICE	EURO/PZ	VERSIONE	PZ
		Dimensioni □ x L mm	
605505		30 x 30 x 140	1

### IDROSCOPINO

Con pulsante di azionamento



#### ROUND

CODICE	EURO/PZ	VERSIONE	PZ
		Dimensioni Ø x H x L mm	
605510		20 x 55 x 120	1

#### Caratteristiche

Materiale ottone cromato  
 Attacco 1/2" M  
 Finitura cromo lucida



#### SQUARE

CODICE	EURO/PZ	VERSIONE	PZ
		Dimensioni □ x L mm	
605511		30 x 30 x 140	1

**SUPPORTO A MURO  
PER DOCCETTA**



Caratteristiche	
Materiale	ottone cromato
Finitura	cromo lucida

CODICE	EURO/PZ	VERSIONE		PZ	
		Modello	Dimensioni mm		
605610		<input type="checkbox"/>	A Round	Ø 28 x H 40	1
605611		<input type="checkbox"/>	B Square	□ 31 x H 20 x L 40	1

**DEVIATORI DI FLUSSO**

**DEVIATORE DI FLUSSO  
PER BRACCIO DOCCIA ROUND**



Permette di inserire una doccetta al braccio doccia senza opere murarie

Caratteristiche	
Materiale	ottone cromato
Dimensioni	Ø 40 x L 62 mm
Attacco E-U	1/2"
Finitura	cromo lucida

CODICE	EURO/PZ	PZ
605600		1

**DEVIATORE SQUARE  
UNIVERSALE**



Caratteristiche	
Materiale	ottone cromato
Dimensioni	□ 40 x L 62 mm
Attacco E-U	1/2"
Finitura	cromo lucida

CODICE	EURO/PZ	PZ
605612		1

**DEVIATORE DI FLUSSO  
PER RUBINETTO**



Permette di inserire un idroscopino al rubinetto del bidet senza opere murarie.

Caratteristiche	
Materiale	ottone cromato
Dimensioni	Ø 25 x H 56 x L 60 mm
Attacco E-U	1/2" M - M22x1 - M24x1
Finitura	cromo lucida

CODICE	EURO/PZ	PZ
605601		1

**PRESE ACQUA A MURO**

**PRESA ACQUA A MURO  
PER FLESSIBILE**

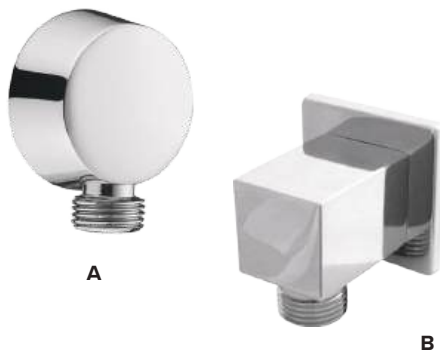

Caratteristiche	
Materiale	ottone cromato
Attacco E-U	1/2"MM
Finitura	cromo lucida

CODICE	EURO/PZ	VERSIONE		PZ	
		Modello	Dimensioni mm		
605602		<input type="checkbox"/>	A Round	Ø 50 x H 24	1
605603		<input type="checkbox"/>	B Square	□ 25 x L 40	1

**PRESA ACQUA A MURO ROUND  
CON PORTA DOCCETTA**



Caratteristiche	
Materiale	ottone cromato
Dimensioni	Ø 32 x H 600 mm
Attacco E-U	1/2"MM
Finitura	cromo lucida

CODICE	EURO/PZ	PZ
605604		1

**PRESA ACQUA A MURO SQUARE  
CON PORTA DOCCETTA  
SCOMPONIBILE**
**Caratteristiche**

Materiale	ottone cromato
Dimensioni	□ 30 x L 650 mm
Attacco E-U	1/2"MM
Finitura	cromo lucida

CODICE	EURO/PZ	PZ
605605		1

**PRESA ACQUA A MURO CON PORTA DOCCETTA  
E VALVOLA DI SICUREZZA**
**Caratteristiche**

Materiale	ottone cromato
Attacco E-U	1/2"MM
Finitura	cromo lucida

CODICE	EURO/PZ	VERSIONE		PZ	
		□	Modello		Dimensioni mm
605606		A	Round	∅ 30 x L 68	1
605607		B	Square	□ 30 x L 68	1

**SIFONI**
**SIFONE ARREDO ALTO  
SQUARE**
**Caratteristiche**

Attacco	1"1/4
Finitura	ottone cromato

CODICE	EURO/PZ	PZ
603902		1

**SIFONE ARREDO BASSO  
ROUND**
**Caratteristiche**

Attacco	1"1/4
Finitura	ottone cromato

CODICE	EURO/PZ	PZ
603901		1

**SIFONE ARREDO ALTO  
ROUND**
**Caratteristiche**

Attacco	1"1/4
Finitura	ottone cromato

CODICE	EURO/PZ	PZ
603900		1

**FLESSIBILE ESTENSIBILE  
IN ACCIAIO INOX AISI 304**
**Caratteristiche**

Attacco	1"1/4
Finitura	acciaio inox

CODICE	EURO/PZ	PZ
060679		1

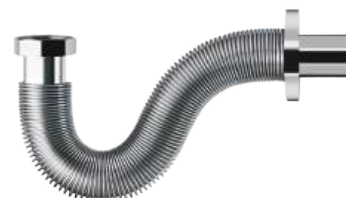



## RUBINETTI PER LAVATRICI



### RUBINETTO DIRITTO PER LAVATRICE

Maniglia in ottone

#### Caratteristiche

Attacco 1/2" x 3/4"  
Finitura cromata

CODICE	EURO/PZ	PZ
607025		1



### RUBINETTO A SFERA PER LAVATRICE

Con maniglia in ABS

#### Caratteristiche

Attacco 1/2" x 3/4"  
Finitura cromata

CODICE	EURO/PZ	PZ
607026		1



A



B

### RUBINETTO A SFERA LUSO PER LAVATRICE

#### Caratteristiche

Attacco 1/2" x 3/4"  
Finitura cromata

CODICE	EURO/PZ	VERSIONE		PZ
		<input type="checkbox"/>	Maniglia	
607027		A	ABS	1
607028		B	Metallo	1



### RUBINETTO A SQUADRA PER LAVATRICE

Chiusura a vitone

#### Caratteristiche

Attacco 1/2" x 3/4"  
Finitura cromata

CODICE	EURO/PZ	PZ
607031		1



### RUBINETTO SALVASPAZIO DOPPIO ATTACCO LAVATRICE

Maniglia in ottone

#### Caratteristiche

Attacco 1/2" x 3/4"  
Finitura cromata

CODICE	EURO/PZ	PZ
607029		1



### RUBINETTO SALVASPAZIO ATTACCO LAVATRICE

Maniglia in ottone

#### Caratteristiche

Attacco 1/2" x 3/4"  
Finitura cromata

CODICE	EURO/PZ	PZ
607030		1



### RUBINETTO BI-USO ATTACCO LAVATRICE

#### Caratteristiche

Attacco 1/2" x 3/4"  
Finitura cromata

CODICE	EURO/PZ	PZ
607032		1

## RUBINETTI CASSETTE WC

### RUBINETTO PER CASSETTA WC

Con maschio girevole ed estraibile  
Con vite di sblocco per estrazione curvetta

**Caratteristiche**

Attacco 1/2" x 10 mm  
Finitura cromata

CODICE	EURO/PZ	PZ
607035		1

### RUBINETTO PER CASSETTA WC CON TUBETTO



**Caratteristiche**

Attacco 1/2" M x 3/8"  
Finitura cromata

CODICE	EURO/PZ	PZ
607036		1

## CANNUCCE

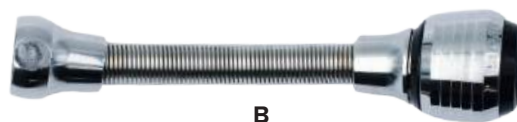
### CANNUCCE



Aeratore in ottone cromato monogetto

Maglia in acciaio inox AISI 304



Aeratore in ABS a doppio getto



Riduzione  
M 24x1 M 22x1

**Caratteristiche**

Finitura cannucchia acciaio inox AISI 304 cromo  
Finitura terminali ottone cromato  
Aeratore Ø 22 x 1 F  
Lunghezza 150 mm

CODICE	EURO/PZ	VERSIONE		PZ
		Getto	Aeratore	
070655		A	Singolo Ottone cromato	1
070660		B	Doppio ABS	1
070697		C	M 24x1 M 22x1	1



## RUBINETTI SOTTOLAVABO



### RUBINETTO SOTTOLAVABO CON FILTRO E SNODO

Funzionamento a vitone e calotta alta

#### Caratteristiche

Attacco 1/2" x 3/8" x 10 mm  
Finitura cromata

CODICE	EURO/PZ	PZ
607023		1



### RUBINETTO A SFERA SOTTOLAVABO

Con filtro e calotta alta

#### Caratteristiche

Attacco 1/2" x 10 mm  
Finitura cromata

CODICE	EURO/PZ	PZ
607020		1



### RUBINETTO A SFERA SOTTOLAVABO

Con filtro e snodo calotta alta

#### Caratteristiche

Attacco 1/2" x 10 mm  
Finitura cromata

CODICE	EURO/PZ	PZ
607021		1



### RUBINETTO SOTTOLAVABO CON FILTRO

Funzionamento a vitone e calotta alta

#### Caratteristiche

Attacco 1/2" x 3/8" x 10mm  
Finitura cromata

CODICE	EURO/PZ	PZ
607022		1

## CURVETTE SOTTOLAVABO



### CURVETTA STAMPATA SOTTOLAVABO

#### Caratteristiche

Attacco 1/2" x 10 mm  
Finitura cromata

CODICE	EURO/PZ	PZ
607010		1



A



B

### CURVETTA SOTTOLAVABO

Con maschio girevole ed estraibile  
Con vite di sblocco per estrazione curvetta

#### Caratteristiche

Attacco 1/2" x 3/8" x 10 mm  
Finitura cromata

CODICE	EURO/PZ	VERSIONE		PZ
		<input type="checkbox"/>	Modello	
607011		<input type="checkbox"/>	A 45°	1
607012		<input type="checkbox"/>	B 90°	1

# PILETTE CLICK CLACK



## ROUND CROMATA

### Caratteristiche

Attacco	1" 1/4
Altezza	H 35 mm
Finitura	Cromata

CODICE	EURO/PZ	PZ
606154		1



## ROUND BASSA CROMATA

### Caratteristiche

Attacco	1" 1/4
Altezza	H 25 mm
Finitura	Cromata

CODICE	EURO/PZ	PZ
606153		1



## SQUARE UNIVERSALE CROMATA

### Caratteristiche

Attacco	1" 1/4
Altezza	H 35 mm
Finitura	Cromata

CODICE	EURO/PZ	PZ
606155		1



## BASSA CROMATA CON TROPPO PIENO

### Caratteristiche

Attacco	1" 1/4
Altezza	H 35 mm
Finitura	Cromata

CODICE	EURO/PZ	VERSIONE		PZ
		<input type="checkbox"/>	Modello	
606156		A	Round	1
606157		B	Square	1



## ALTA CROMATA CON TROPPO PIENO

### Caratteristiche

Attacco	1" 1/4
Altezza	H 35 mm
Finitura	Cromata

CODICE	EURO/PZ	VERSIONE		PZ
		<input type="checkbox"/>	Modello	
606158		A	Round	1
606159		B	Square	1



Indice in ordine alfabetico	pagine
<b>BOX DOCCIA</b>	
<b>LINEA LOFTY</b>	2-11
<b>LINEA ACRIL</b>	14-17
Raccordo per due pareti doccia Walk - in	11
Accessori e ricambi per box doccia Linea LoftY	12
<b>BRACCIO DOCCIA</b>	
<i>Round - Square</i>	46-47
<b>COMPLEMENTI BAGNO - ACCESSORI</b>	
<i>Sifoni</i>	51
<i>Rubinetti per lavatrici</i>	52
<i>Rubinetti per cassette WC</i>	53
<i>Cannucce</i>	53
<i>Rubinetti sottolavabo</i>	54
<i>Curvette sottolavabo</i>	54
<i>Pilette click clack</i>	55
<b>COMPLEMENTI DOCCIA - ACCESSORI</b>	
<i>Supporto a muro per doccetta</i>	50
<i>Deviatori di flusso</i>	50
<b>DOCCETTE</b>	
<i>Monogetto e plurigetto</i>	48-49
<i>Shut - off</i>	49
<i>Idroscopino</i>	49
<b>FLESSIBILI DOCCIA</b>	
<b>SPRING LINE</b>	38
<b>SIMPLE LINE</b> <i>Round PVC - Square PVC - Steel</i>	39
<b>KIT DOCCIA</b>	
<i>Steel Round - Steel Square</i>	41
<i>Duplex Round</i>	42
<i>Duplex Square</i>	43

Indice in ordine alfabetico	pagine
<b>KIT IDROSCOPINO</b>	
<i>Round Elegant - Square Elegant</i>	45
<b>KIT SHUT - OFF</b>	
<i>Round Classic - Square Classic - Round Fast</i>	44
<i>Round Elegant - Square Elegant</i>	45
<b>PIATTI DOCCIA</b>	
<b>PIATTI DOCCIA ZERO in Mineral Plane</b>	18 - 23
Accessori e ricambi per piatti doccia ZERO	23
<b>SALISCENDI</b>	
<i>White Sun - Black Sun</i>	40
<b>SALISCENDI</b>	
<i>White Sun - Black Sun</i>	40
<b>SISTEMA DI SCARICO A PAVIMENTO PER DOCCIA</b>	
<b>INOX STYLE</b>	24-25
<i>Linea Luxury rettangolare</i>	26-27
<i>Linea Luxury quadrata</i>	30
<i>Linea Ram Rettangolare</i>	28-29
<i>Linea Ram triangolare</i>	31
<i>Chiusino sifonato quadrato</i>	32
<b>INOX SLOT</b>	33
<i>Linea Floor</i>	34
<i>Linea Wall</i>	35
<i>Linea Floor 2DS</i>	36-37
<b>SOFFIONI DOCCIA</b>	
<i>Low Round - Low Square</i>	46-47



**Per le nostre condizioni di vendita  
inquadra il QR code**



**SEDE:** via 1° Maggio, 7 - 21012 Cassano Magnago (VA) Tel: 0331 - 20.49.11 r.a. - Fax: 0331 - 20.14.58  
E-mail: ferrarivarese@ferrariwelcome.it

**FILIALE:** via S. Pieretto, 50 - 55060 Capannori (LU) Tel: 0583 - 941.41 r.a. - Fax: 0583 - 946.82  
E-mail: ferrarilucca@ferrariwelcome.it

**FILIALE:** viale dell'Artigianato, 276 - 35047 Solesino (PD) Tel: 0429 - 76.72.27 - Fax: 0429 - 70.18.10  
E-mail: ferraripadova@ferrariwelcome.it

SCARICA LA NOSTRA APP



APP ANDROID



APP IOS

SEGUICI SUI NOSTRI  
CANALI SOCIAL



FACEBOOK



INSTAGRAM



YOUTUBE

Edizione aprile 2023



PAP